

MiMo Directional Antenna

WMM8G-7-38

PANORAMA ANTENNAS



- Provides 2x2 MiMo antenna system for 4G/5G
- Two wideband elements with medium gain
- Durable housing for external or internal use
- Suitable for mast, wall and desk mounting

The WMM8G antenna provides an innovative and future proof solution for 3G/4G and 3.4-3.8GHz 5G networks. Incorporating two separately fed, ultra wideband elements in a single housing, it provides a client side 2x2 MiMo antenna system for the networks of today and tomorrow. With between 6-9dBi gain in the range 698-3800MHz, the WMM8G gives great performance, whilst maintaining a wide beam pattern which is ideal for metro and urban areas.

The rugged, weatherproof housing is designed for wall or mast mounting and hardware is provided. A desk stand is also included to enable the antenna to be positioned on a window sill if preferred.

The antenna is supplied with integral "twinned" CS29 coaxial cable. WMM8G-7-38-5SP version has 5m length, fitted with sma plug connectors for a simple 'plug & play' installation. WMM8G-7-38-03NJ version has 30cm length, fitted with N socket connectors, which enables use of lower loss cable types for longer runs.

The WMM8G is a cost effective value added product for network operators and service providers ensuring a stable network connection with improved data rates for subscribers, improving satisfaction and retention.

Technical Drawing

WMM8G-7-38-5SP Shown

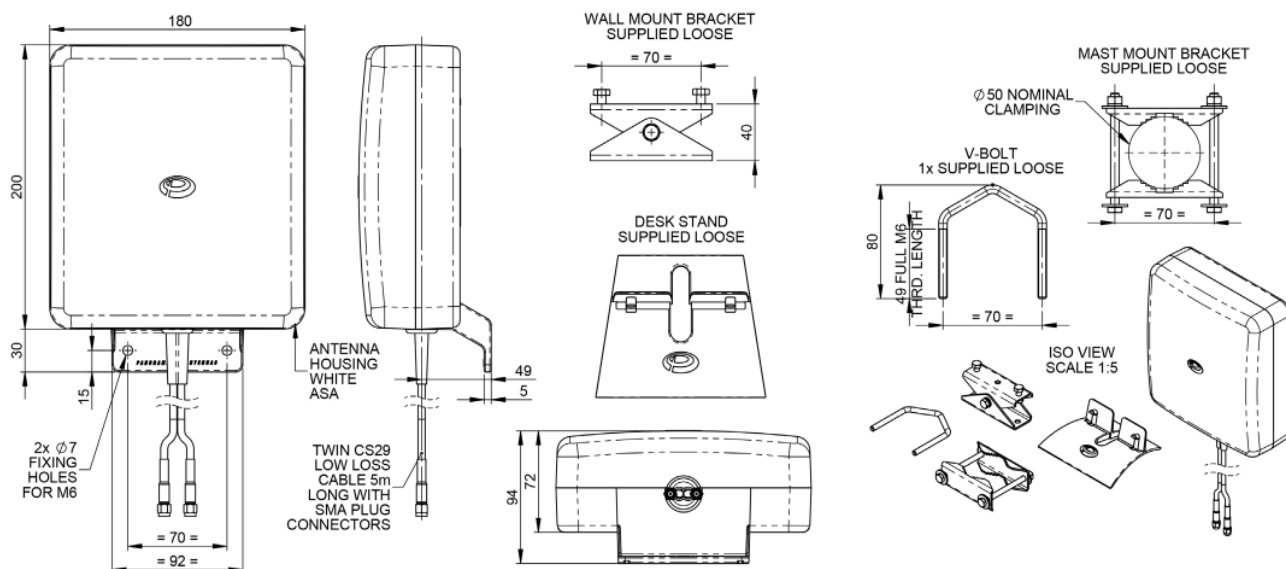

MiMo Directional Antenna

WMM8G-7-38

PANORAMA  ANTENNAS

Product Data

Part No.		WMM8G-7-38-5SP	WMM8G-7-38-03NJ
Electrical Data			
Frequency Range (MHz)	Antenna 1	698-960/1710-2700/3400-3800	
	Antenna 2	698-960/1710-2700/3400-3800	
Operational bands	2G / 3G / 4G / 5G		
Radiation pattern	Directional		
Nominal Polarisation	+/- 45deg Vertical		
Peak Gain (excl cable loss)+	698-960 MHz	6dBi	
	1710-2170 MHz	9dBi	
	2396-2700 MHz	9dBi	
	3400-3800MHz	9dBi	
Efficiency - excluding cable loss (all bands)	> 60%		
Correlation co-efficient (all bands)	< 0.1		
Max input power (W)	20 Watts		
Nominal Impedance	50Ω		
Mechanical Data			
Dimensions (mm)	Height	230 (9")	
	Width	180 (7.1")	
	Depth	94 (3.7")	
Operating temp (°C)	-45° / +80°C (-49° / 176°F)		
Material	U.V. stable, impact resistant ASA		
Colour	RAL9010 (Pure White)		
Weight (g)	955		
Ingress Protection	IP 65		
Mounting Data			
Fixing	Wall mount / mast mount / desk mount		
Mounting bracket material	Stainless steel / Aluminium		
Pole diameter (mm)	20-50 / (0.78 - 1.96")		
Cable Data			
Type	2 x CS29	2 x CS29	
Diameter (mm)	5 (0.2")	5 (0.2")	
Length (m)	5 (16')	0.3 (12")	
Termination	2 x SMA (m)	2 x N(f)	

+ Swept peak gain simulated in CST Microwave studio for each element excluding cable loss

Electrical Data - Cell

Typical VSWR Elements 1 & 2 *

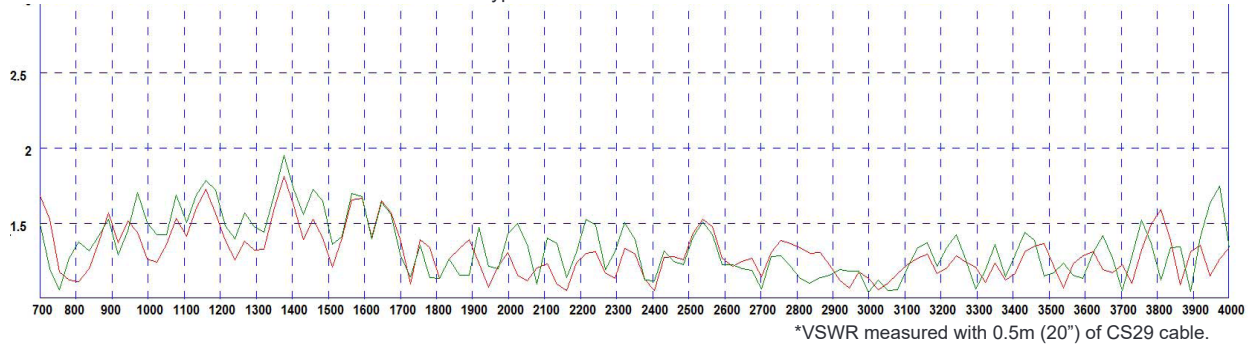

Typical Isolation Elements 1 & 2 *

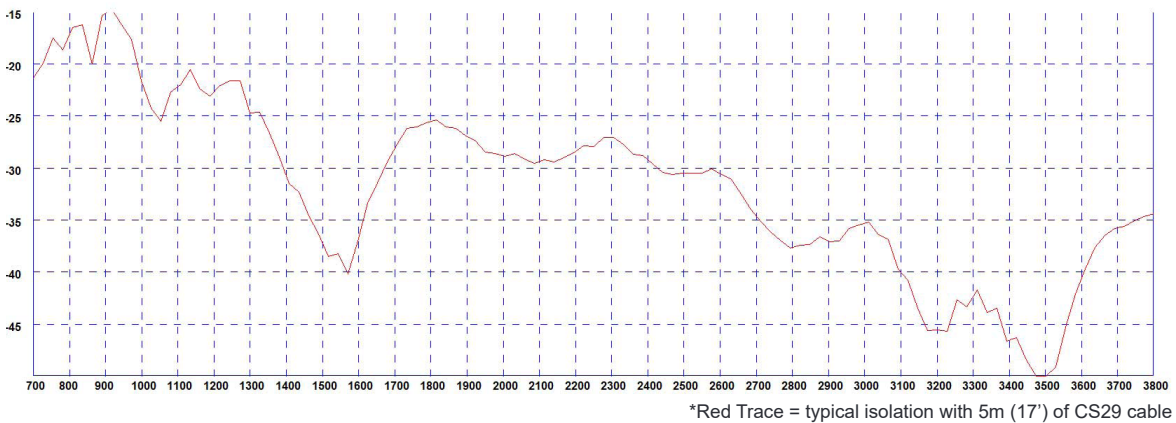

Swept Peak Gain Elements 1 & 2 *

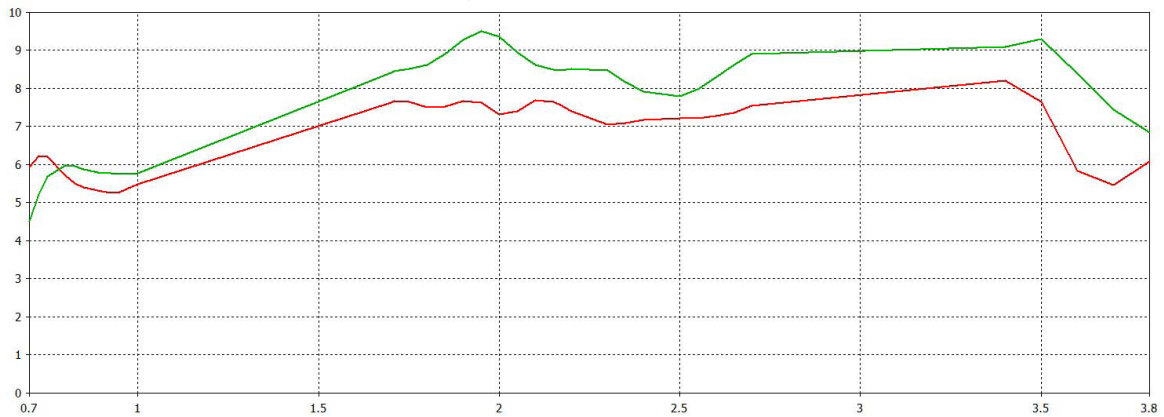

*Elements 1 & 2 swept peak gain without cable simulated in CST Microwave Studio

3D Gain Plot (750MHz)

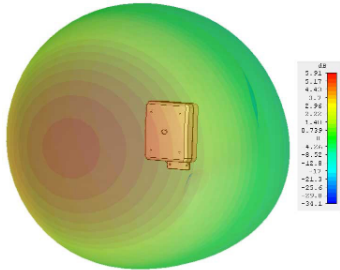

3D Gain Plot (850MHz)

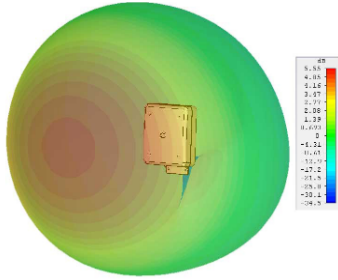

3D Gain Plot (950MHz)

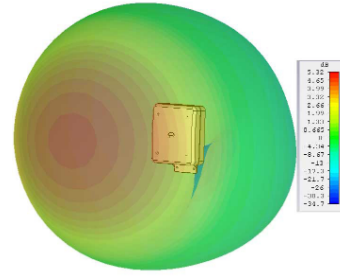

3D Gain Plot (1800MHz)

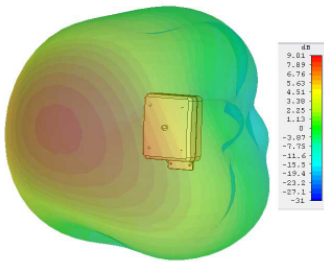

3D Gain Plot (2000 MHz)

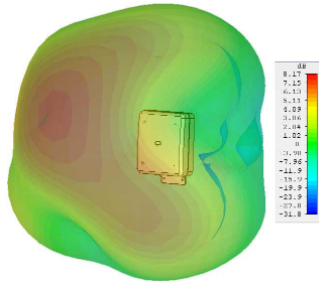

3D Gain Plot (2600 MHz)

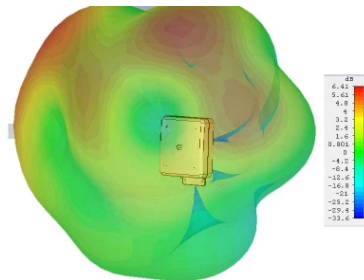

3D Gain Plot (3600MHz)

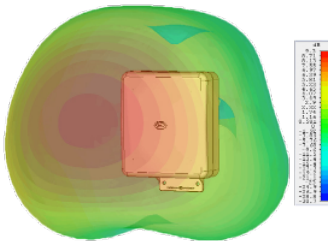

*WMM8G-7-38 3D Patterns show realised gain both elements fed modelled in CST Microwave Studio without additional cable.