

FALCON

Installation Instructions

Required Tools & Accessories

Phillips Screwdriver

5/16" Drill Bit

7/32" Drill Bit

Loctite or 3M Red 271 Thread locker

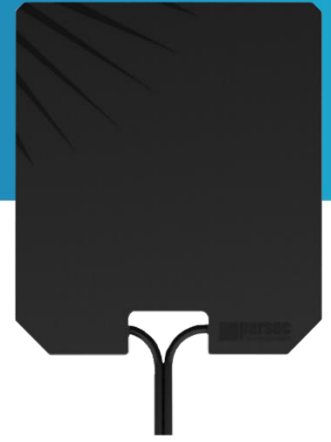

Mounting Options

Antenna Mounting Location Directions

When selecting the location of an antenna, consider the following factors:

- 1. Antenna Directionality** – the direction of the signal is limited by the directionality of the antenna. **Omni-directional antennas** provide a 360-degree horizontal radiation pattern, allowing for coverage in all directions horizontally with varying degrees of vertical coverage. **When selecting the location of an omni-directional antenna, ensure that the antenna can be mounted in the proper orientation relative to the horizontal plane.**
- 2. Signal Path Loss** – signal strength is greatly affected by the materials that the signal passes through. Severe signal loss can be caused by concrete and brick walls. Metals can absorb and/or reflect the signal, affecting the signal path. **For best antenna performance, select an antenna location with minimal obstructions between the antenna and the signal source(s).**
- 3. Reflection & Diffraction** – the signal will bounce off certain materials and bend around obstacles. For best antenna performance, the antenna should be installed in a location where the signal path is not interfered with by materials like Low E glass, Metal, Tinted glass, etc., that reflect RF Energy.
- 4. Interference** – electrical devices and appliances interfere with the antenna's signal.

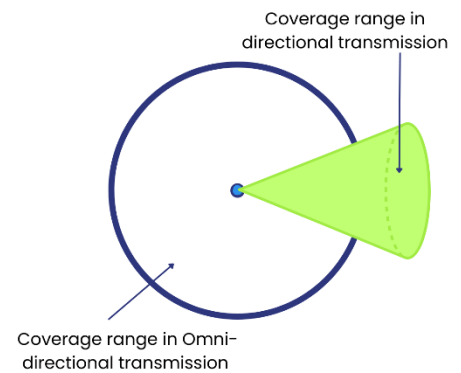

Electrical devices and appliances, such as refrigerators, microwaves, AC units, and cameras, can cause electromagnetic interference with the antenna signal. **Select a location that is as far as possible from electrical devices and appliances and minimizes the amount of such devices between the antenna and the signal source(s). For best antenna performance, install antennas as far away as**

Low-E Windows and Wireless Signal Inside LEED-Certified Buildings

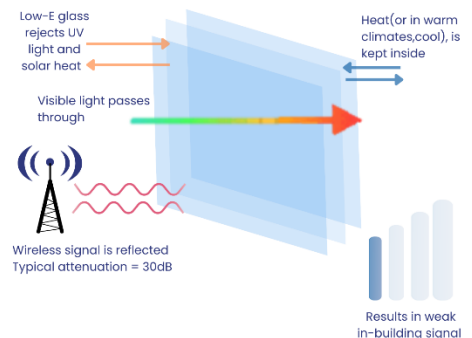

possible from each other and other devices. In general, separate antennas by at least 24 inches (61 cm).

5. **Cable Loss** – signal strength is lost as RF waves travel through cables.

The longer the cable, the more electrical energy is lost as heat and the higher the signal loss.

Therefore, it is best to select a location for the antenna that allows the cables to be as short as possible and still reach the router.

The size of the cable also affects cable loss; coaxial cables with higher center conductor diameters have less cable loss compared to thinner coaxial cables.

It is critical to avoid bending coaxial cables sharply to avoid shearing of the Aluminum foil shield, which can result in a significant or complete loss of antenna functionality.

Coaxial cables should not be bent sharply; they have a minimum bend radius which varies depending on the size of cable.

Hardware Accessories

<i>Accessory</i>	<i>Part Number</i>
Lightning Arrestor – SMA(F) to SMA(F)	PTA0476
Lightning Arrestor – N(F) to N(M)	PTA0736
SMA Wrench, Key Chain	PTA0194
Service: Cable Sleeving (Priced Per Ft)	Cable Sleeving

***Lightning Arrestors are recommended for outdoor installation**

Wall Mount: Hanging

1. Select the mounting location.
 - A. To avoid de-tuning or interference issues, install the antenna as far away as possible from other devices (minimum 24 inches), including lights, AC units, routers, and other antennas.
 - B. Mount the antenna so that it is centered on a wall stud.
 - C. Ensure that there is no metal in the wall behind the antenna.
2. Drill one 0.25" diameter hole into the wall.
 - A. Use a ¼" diameter drill bit to drill the hole at the location.
3. Install the provided wall anchor and screw into the wall.
 - A. Insert the wall anchor into the hole. Ensure that the anchor is fully inserted.
 - B. Insert the screw into the wall anchor and tighten until the screw head is ¼" away from the wall.
4. Hang the antenna on the screws.
5. Secure the antenna cables to the wall roughly 6 inches below the antenna to provide strain relief. Vinyl electrical tape or cable-ties can be used. If using cable-ties outside, make sure to use UV resistant cable-ties.
 - A. Ensure that the antenna cables run vertically at least 8" under the antenna.
 - B. Ensure that the cables do not bend sharply. Do not bend the cables with a radius of 1.5" or less.
 - C. Route the antenna cables adjacent to existing wiring as much as possible.

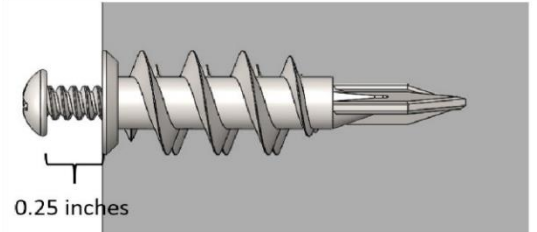

Window Mount

1. Select the mounting location.
 - A. To avoid de-tuning or interference issues, install the antenna as far away as possible from other devices (minimum 24 inches), including lights, AC units, routers, and other antennas.
 - B. A clear line of sight to the nearest cell tower is recommended for best performance.
 - C. For multiple Falcon antennas, antennas must be separated at least 12 inches vertically or 24 inches horizontally.
 - D. Ensure that the window is not low emissivity (Low-E) glass.
2. Assemble the window mount bracket and suction cup onto the antenna.
 - A. Insert the suction cup into the keyhole slot on the antenna.
3. Connect the SMA(F) ends of the cables in the SMA(M) to SMA(F) cable kit to the connectors on the antenna.
4. Using the suction cup, mount the antenna on a glass window on the interior face at least 24 inches away from other devices or obstructions.
 - A. For best performance, rotate the antenna so that the front is facing the direction of the nearest cellular tower.
5. Secure the antenna cables roughly 6 inches below the antenna to provide strain relief. Vinyl electrical tape or cable-ties can be used. If using cable-ties outside, make sure to use UV resistant cable-ties.
 - A. **Ensure that the cables do not bend sharply. Do not bend the cables with a radius of 1.5" or less.**
 - B. Route the antenna cables adjacent to existing wiring as much as possible

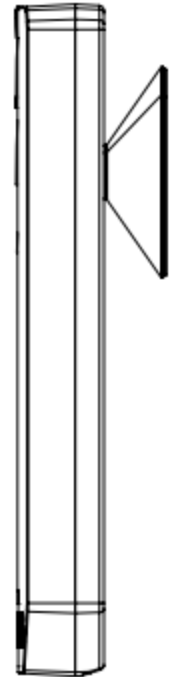
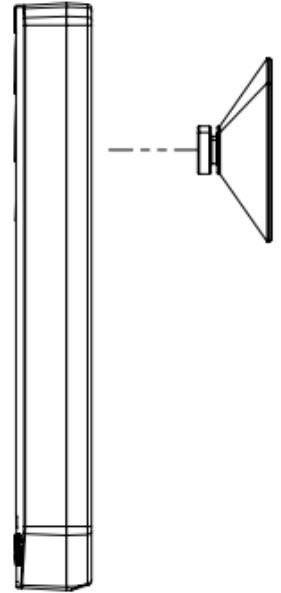
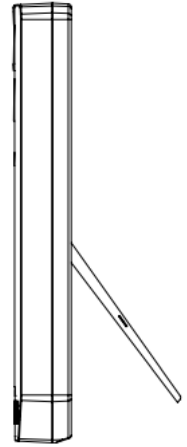

Table Mount

1. Select the mounting location.
 - A. To avoid de-tuning or interference issues, install the antenna as far away as possible from other devices (minimum 24 inches), including lights, AC units, routers, and other antennas.
 - B. Find a suitable location with a high friction surface and out of the way of accidental pushing or pulling of cables.
 - C. A clear line of sight to the nearest cell tower is recommended for best performance.
 - D. Unfold the legs at the base of the antenna and place the antenna upright.



Routing the Cable

1. Properly route the cables, making sure there are no sharp bends. Clamp the cables to the wall at about 6 inches away from the antenna if the cables are being hung straight from the wall.
2. Make sure the antenna is mounted in the correct direction and tighten the mounting hardware. Waterproof the RF connectors using electrical tape, or a heat shrink tube.

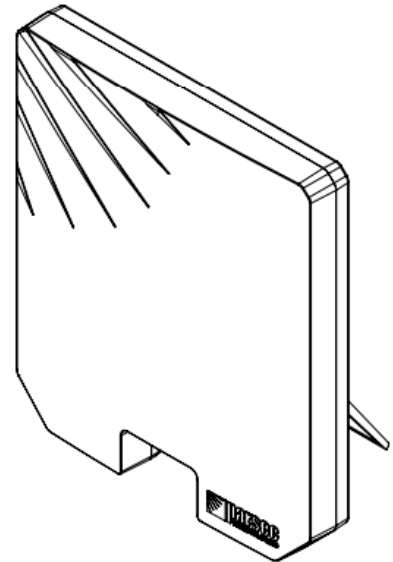

Cable Connection Instructions

Step 1:

Use canned air and/or isopropyl alcohol to clean all the connectors to ensure that there is no dust in the terminals.

Step 2.

Connect the antenna cables to the designated terminals on the router, as shown in the tables and images below:

S. No	Cable from Antenna	Connector on Router
1	CELL 1	MAIN0
2	CELL 2	AUX0 / DIV

Commission and Testing

Check each coaxial cable connector and confirm that it cannot be easily loosened. Visually inspect the coaxial cables to ensure that they are not sharply bent and are sufficiently secured and supported between the antenna and the router.

Use a cellular device's built-in diagnostics to confirm the RSSI is higher than -75dB. Confirm the cellular connection supports communications at required data rates.

Connect the cellular/LTE cables to the router and stow any unused coaxial cables to avoid damage.

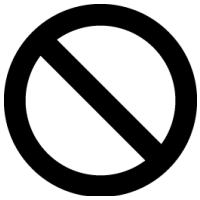

CAUTION

To comply with FOC RF Exposure requirements in section 1.1310 of the FCC Rules, antennas used with this device must be installed to provide a separation distance of at least 20 cm from all persons to satisfy RF exposure compliance.



DO NOT

- Operate the transmitter when someone is within 24 inches of the antenna
- Install the antenna or mast assembly on a windy day
- Install the mast close to power lines as it can cause serious injuries or death



WARNING

Watch out for overhead power lines. Check the distance to power lines before beginning installation.



WARNING

This document gives the detailed instructions to install an antenna to the best of our knowledge. This document is for general information only. It cannot be used as a warranty. Parsec Technologies Inc. will not accept any liability for any damage caused by an antenna due to unknown variables.



Last Revised: 08.07.2023