



## Data Sheet

# E3000 Series Enterprise Router



The Cradlepoint NetCloud for Branch with E3000 Series Enterprise Router is suited for fixed offices, healthcare, financial services and retail locations, ideally when combined with need for security services at scale with performance. The all-in-one form factor includes full-featured routing, security, switching with PoE ports and Wi-Fi, making it easy to connect branches to the Internet and critical applications without the need for extra hardware or complicated configurations. And the embedded LTE or 5G modem means that connectivity is always available from day one without waiting for a wired connection.

## Notable Features

- Gain agility through an embedded Cat 18 LTE or 5G NR modem for fast day-1 or primary connectivity.
- Terminate a primary wired broadband link with LTE or 5G as failover for highly resilient hybrid connectivity.
- Enable larger branch locations needing security and connections to cloud-based applications.
- Integrate into your existing network with standards-based dynamic routing and VPN tunnel support.
- Define policies through centralized, cloud-based management for easy deployment at scale.
- Add a second cellular modem for dual LTE or 5G connectivity.
- Add hardware redundancy by pairing mirrored routers with VRRP to optimize uptime.

## Ideal for Wireless WAN

For an all wireless WAN, the E3000 Series router offers Gigabit LTE or 5G NR1 performance, which can support the throughput and service needs of an enterprise branch office or store with the ability to add a second LTE or 5G connection for increased available bandwidth and reliability. For organizations moving to a Wireless WAN, the E3000 Series router offers the ability to pair with a wired link and use LTE or 5G as a failover connection or a primary connection.

## 5G Performance Embedded or Optimized

The E3000 Enterprise Branch Router offers 5G performance in two form factors. As a router with embedded 5G, the platform ships standard with the modem as well as a second slot for dual modem capabilities. As a 5G-optimized LTE router, it has the ability to act as a controller for a Cradlepoint 5G Wideband Adapter so that the modem can be placed for optimal signal coverage. The unique capability of Cradlepoint to operate the adapter in captive mode means that the two separate, Ethernet-connected appliances can be managed as a single entity. The two form factors ensure 5G performance in the manner that best suits the deployment needs.

## Performance

Stateful Firewall Throughput:	IPS Throughput:	Application Aware Services & Analytics	IPSec VPN Throughput:	Concurrent VPN Tunnels:	Concurrent Sessions (TCP):	Typical Client Count:
<b>2 Gbps</b>	<b>1.5 Gbps</b>	<b>1.5 Gbps</b>	<b>400 Mbps</b>	<b>20</b>	<b>130,000</b>	<b>100</b>

Performance testing was conducted based on requirements as defined in RFC2544 using fixed-frame 1518 byte packets. Throughput results reflect uni-directional UDP traffic with less than 1% packet loss as tested with wired connections.

Results do not reflect performance of the cellular wireless operator networks.

## Key Software Capabilities

The Cradlepoint NetCloud for Branch with E3000 Series Router provides everything needed to unlock the power of LTE or 5G at the network edge and connect users and IoT devices to critical applications and services. NetCloud includes routing, VPN, SD-WAN, and security capabilities for robust, enterprise-class performance. Cloud-based management designed for simplification, insights and scale includes group policy definition, reports, troubleshooting, and analytics dashboards. The service includes a warranty for as long as there is an active subscription on the router, online training, live and online support, and all software and firmware updates.

## Router Services

The next generation hardware has the processing power to handle demanding router-delivered services, dynamic routing protocols, and application aware traffic steering, supported with our exclusive NetCloud Essentials + Advanced software package.

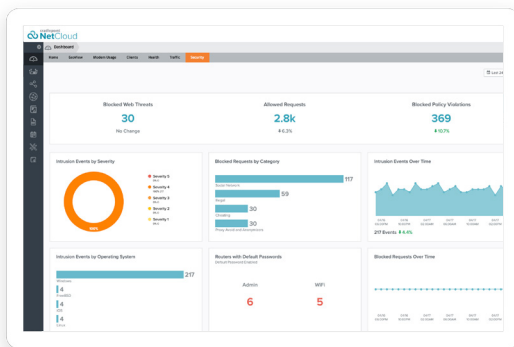
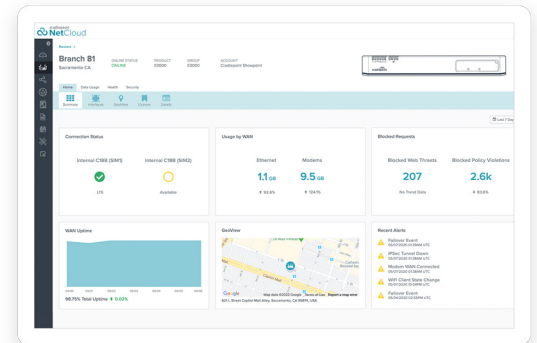

## Security Services

NetCloud Essentials + Advanced packages include security features and options, such as stateful zone-based firewall, intrusion prevention, and threat protection, to optimize the E3000 series router to meet the evolving security needs of distributed environments. Additional security add-ons from leading technology partners make a rich security stack manageable from NetCloud.

## Connection Manager

Connection Manager provides the ability to manage all WAN connections types, both wireless and wired, from a single software-defined policy. Our custom-built modem software ensures users establish Wireless WAN connectivity faster while maintaining the highest level of resiliency.

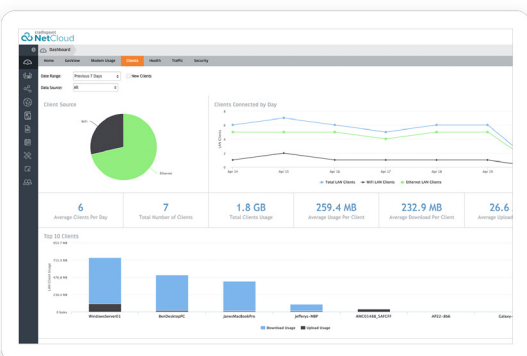
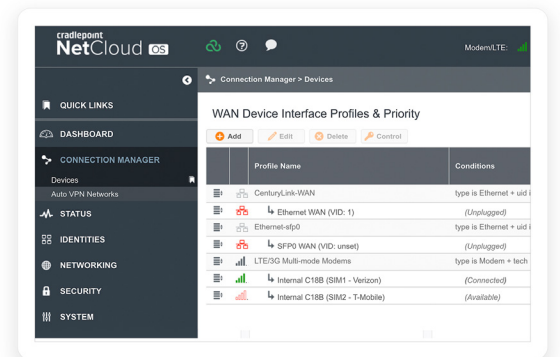

## Cloud Services

NetCloud Manager delivers true zero-touch deployment with the ability to define and deliver policy across entire groups of endpoints. Users can create a cloud-orchestrated hub and spoke VPN network and gain insights and analytics required for rapid troubleshooting and diagnostic workflows.

# Hardware Specifications

The following features are delivered through the hardware.

INTERFACES	
<b>Modem:</b>	One of the following: <ul style="list-style-type: none"> <li>— Embedded 5GB Low/Mid-Band Modem               <ul style="list-style-type: none"> <li>— 4 x SMA cellular antenna connectors</li> </ul> </li> <li>— Embedded C18B Modem               <ul style="list-style-type: none"> <li>— 4 x SMA cellular antenna connectors</li> </ul> </li> </ul> Optional dual modem: <ul style="list-style-type: none"> <li>— Modular MC400 modem</li> </ul>
<b>Ethernet:</b>	9 x GbE RJ45 (LAN/WAN switchable) 1 x 2.5GbE RJ45 (LAN/WAN switchable) 1 x 10GbE SFP+ (LAN/WAN switchable) <ul style="list-style-type: none"> <li>— SFP: Finisar FTLF8519P3BNL, FTLF1318P3BTL</li> <li>— SFP+: Finisar FTLX8574D3BCL, FTLX1475D3BCL, FCBG110SD1Cxx</li> </ul>
<b>PoE:</b>	4 x 802.3bt PoE Type 3/4 (up to 90W per port) <ul style="list-style-type: none"> <li>— 140W total PoE power budget</li> </ul>
<b>Wi-Fi:</b>	Dual-radio, dual-band, concurrent operation (2.4 GHz and 5 GHz) <ul style="list-style-type: none"> <li>— 4x4 MU-MIMO 802.11ax Wi-Fi 6 with DFS</li> <li>— 1,148 Mbps (2.4 GHz) and 2,400 Mbps (5 GHz)</li> <li>— External 4x4 antennas</li> <li>— Global Optimized Wi-Fi</li> <li>— WPA/WPA2/WPA3 Personal, WPA2/WPA3 Enterprise, Open</li> <li>— 802.11k, 802.11r, 802.11v</li> </ul>
<b>Expansion / Console:</b>	1 x USB 2.0 Type A (Output: 5V, 500mA, 2.5W) 1 x Expansion Slot <ul style="list-style-type: none"> <li>— MC20BT Bluetooth Low Energy module</li> </ul> 1 x RJ45 Console
<b>GNSS/GPS:</b>	1 x SMA GNSS antenna connector
ENVIRONMENTAL	
<b>Temperature:</b>	Operating: 0 °C to 50 °C (32 °F to 122 °F) Storage: -20 °C to 85 °C (-4 °F to 185 °F)
<b>Humidity:</b>	Operating: 10% to 90% Storage: 5% to 95%
POWER	
<b>Required:</b>	Powered by external DC power supply, 100-240 VAC input, 54 VDC 3.34A output (included)
<b>Consumption:</b>	Idle: 17 W Typical: 19 W Heavy: 24 W
PHYSICAL	
<b>Size:</b>	6.3 x 12.6 x 1.7 in (160 x 320 x 44 mm)
<b>Weight:</b>	4 lb 6 oz (1.98 kg)
CERTIFICATIONS	
<b>Safety:</b>	UL/cUL, CB Scheme, EN 62368-1
<b>Materials:</b>	WEEE, RoHS, REACH, California Prop 65
WI-FI POWER	
<b>FCC:</b>	2.4 GHz: 26.22 dBm Conducted 5150–5250 MHz: 28.63 dBm Conducted 5725–5850 MHz: 28.65 dBm Conducted
<b>IC:</b>	2.4 GHz: 26.22 dBm Conducted 5150–5250 MHz: 21.70 dBm Conducted 5725–5850 MHz: 28.65 dBm Conducted
LEDs	
Refer to the <a href="#">E3000 Series Enterprise Branch Router Quick Start Guide</a> .	

## Enterprise-Class Modem Specifications

SPECIFICATION	E3000-C18B				
<b>Technology:</b>	Cat 18 LTE Advanced Pro (3GPP Rel. 12) <ul style="list-style-type: none"> <li>— Dual SIM slots, 2FF form factor</li> <li>— SIM-based auto-carrier selection</li> </ul>				
<b>Fallback:</b>	WCDMA/UMTS/HSPA+				
<b>Carrier Aggregation:</b>	Up to 5CA downlink, 2CA uplink Refer to the <a href="#">Modem Carrier Aggregations</a> article.				
<b>Peak Downlink Rates:</b>	LTE: 1.2 Gbps WCDMA: 42.2 Mbps				
<b>Peak Uplink Rates:</b>	LTE 150 Mbps WCDMA: 5.76 Mbps				
<b>MIMO:</b>	4x4 MIMO				
<b>QAM:</b>	Up to 256				
<b>LTE Bands:</b>	<table border="0" style="width: 100%;"> <tr> <td style="width: 50%;">LTE FDD</td> <td style="width: 50%;">LTE TDD</td> </tr> <tr> <td> <ul style="list-style-type: none"> <li>— B1, B2, B3, B4, B5, B7, B8, B12, B13, B14, B17, B18, B19, B20, B25, B26, B28, B29, B30, B32, B66, B71</li> </ul> </td> <td> <ul style="list-style-type: none"> <li>— B38, B39, B40, B41, B42, B43, B46, B48</li> </ul> </td> </tr> </table>	LTE FDD	LTE TDD	<ul style="list-style-type: none"> <li>— B1, B2, B3, B4, B5, B7, B8, B12, B13, B14, B17, B18, B19, B20, B25, B26, B28, B29, B30, B32, B66, B71</li> </ul>	<ul style="list-style-type: none"> <li>— B38, B39, B40, B41, B42, B43, B46, B48</li> </ul>
LTE FDD	LTE TDD				
<ul style="list-style-type: none"> <li>— B1, B2, B3, B4, B5, B7, B8, B12, B13, B14, B17, B18, B19, B20, B25, B26, B28, B29, B30, B32, B66, B71</li> </ul>	<ul style="list-style-type: none"> <li>— B38, B39, B40, B41, B42, B43, B46, B48</li> </ul>				
<b>5G NR Bands:</b>	N/A				
<b>WCDMA Bands:</b>	B1, B2, B4, B5, B8, B19				
<b>Power:</b>	LTE 23 dBm ± 1, DC-HSPA+ 23 dBm ± 1 (typical conducted)				
<b>Antennas:</b>	SMA female connectors, external 600 MHz - 6 GHz cellular paddle antennas (Qty 4, included)				
<b>GNSS/GPS:</b>	Active GNSS <ul style="list-style-type: none"> <li>— GPS, GLONASS, BeiDou, Galileo</li> <li>— DC voltage bias supplied (typical 3.1V)</li> </ul>				
<b>SMS:</b>	Yes				
<b>Regulatory:</b>	FCC (U.S.), IC (Canada), CE (EU), RCM (AU/NZ)				
<b>Network Operator Standards:</b>	PTCRB (U.S., Canada), GCF (Worldwide)				
<b>Network Operator Certifications:</b>	AT&T, Verizon, Telstra (Cat 16) <sup>†</sup>				
<b>Public Safety Network Certifications:</b>	FirstNet Ready™ (including Band 14)				
<b>Private Cellular Network:</b>	Yes, includes FCC Part 96 (CBRS Band 48)				

<sup>†</sup>Cellular carriers and operators throughout the world may only require telecom industry certifications, like PTCRB or GCF, to operate on their network. Some carriers require additional testing and approval, beyond telecom certifications, to operate on their network. A carrier listed in the approvals section means Cradlepoint completed additional testing and acquired technical approval for that given carrier. Any carrier not listed may not require additional testing or approval beyond telecom industry certifications to operate on their network.

## Enterprise-Class Modem Specifications

SPECIFICATION	E3000-5GB				
<b>Technology:</b>	5G NR (Low/Mid-Band FR1) and 4G LTE Category 20 LTE Advanced Pro with Dual Connectivity — Dual SIM slots, 2FF form factor				
<b>Fallback:</b>	WCDMA/UMTS/HSPA+				
<b>Carrier Aggregation:</b>	LTE only; up to 7CA downlink, 2CA uplink ENDC 5G + LTE; downlink and uplink supported Refer to the <a href="#">Modem Carrier Aggregations</a> article.				
<b>Peak Downlink Rates:</b>	Up to 4.14 Gbps — based on 20 Layers LTE + TDD (100 MHz BW, 256 QAM, 4X4)				
<b>Peak Uplink Rates:</b>	Up to 660 Mbps — based on 2 Layers LTE + TDD (100 MHz BW, 256 QAM, SISO)				
<b>MIMO:</b>	4x4 MIMO				
<b>QAM:</b>	Up to 256 — FR1				
<b>LTE Bands:</b>	<table border="0"> <tr> <td>LTE FDD</td> <td>LTE TDD</td> </tr> <tr> <td>— B1, B2, B3, B4, B5, B7, B8, B12, B13, B14, B17, B18, B19, B20, B25, B26, B28, B29, B30, B32, B66, B71</td> <td>— B34, B38, B39, B40, B41, B42, B46, B48</td> </tr> </table>	LTE FDD	LTE TDD	— B1, B2, B3, B4, B5, B7, B8, B12, B13, B14, B17, B18, B19, B20, B25, B26, B28, B29, B30, B32, B66, B71	— B34, B38, B39, B40, B41, B42, B46, B48
LTE FDD	LTE TDD				
— B1, B2, B3, B4, B5, B7, B8, B12, B13, B14, B17, B18, B19, B20, B25, B26, B28, B29, B30, B32, B66, B71	— B34, B38, B39, B40, B41, B42, B46, B48				
<b>5G NR Bands:</b>	n1, n2, n3, n5, n28, n41, n66, n71, n77, n78, n79				
<b>WCDMA Bands:</b>	B1, B2, B3, B4, B5, B6, B8, B9, B19				
<b>Power:</b>	LTE only; 23 dBm ± 1 (typical conducted) ENDC 5G + LTE; 20 dBm ± 1 (typical conducted)				
<b>Antennas:</b>	SMA female connectors, external 600 MHz - 6 GHz cellular paddle antennas (Qty 4, included)				
<b>GNSS/GPS:</b>	Passive GNSS (multiplex with DIV/MIMO2 antenna ports)				
<b>SMS:</b>	Yes				
<b>Regulatory:</b>	FCC (U.S.), IC (Canada), CE (EU), RCM (AU/NZ)				
<b>Network Operator Standards:</b>	PTCRB (U.S., Canada), GCF (Worldwide)				
<b>Network Operator Certifications:</b>	AT&T, T-Mobile, Verizon <sup>†</sup>				
<b>Public Safety Network Certifications:</b>	N/A				
<b>Private Cellular Network:</b>	Yes				

<sup>†</sup>Cellular carriers and operators throughout the world may only require telecom industry certifications, like PTCRB or GCF, to operate on their network. Some carriers require additional testing and approval, beyond telecom certifications, to operate on their network. A carrier listed in the approvals section means Cradlepoint completed additional testing and acquired technical approval for that given carrier. Any carrier not listed may not require additional testing or approval beyond telecom industry certifications to operate on their network.

# Hardware

## Physical Measurements

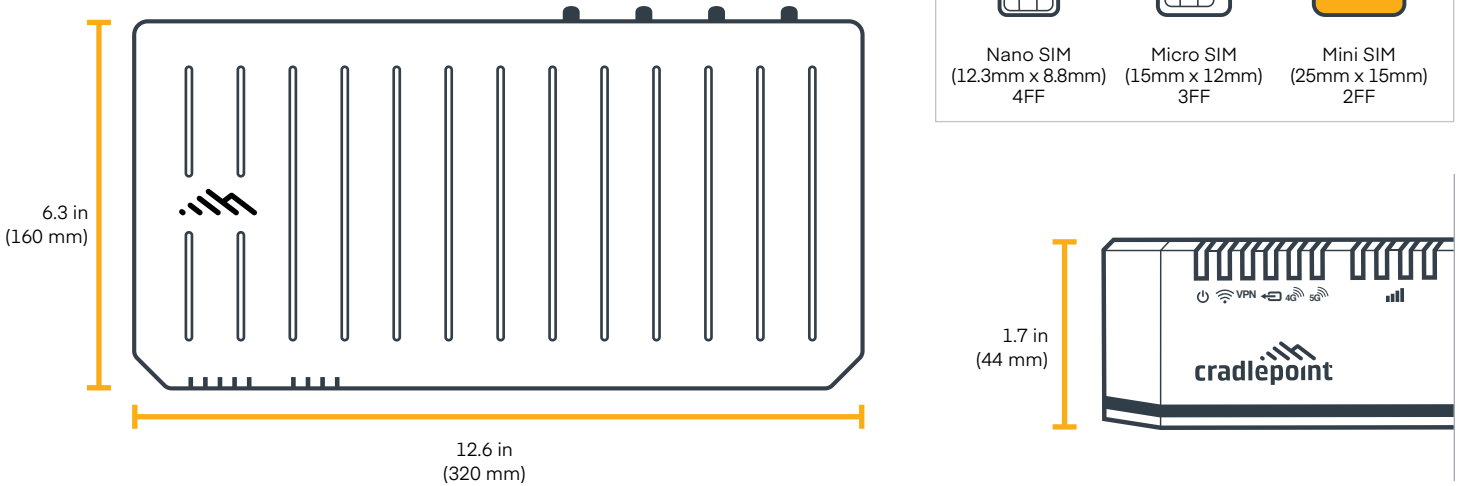

## Front View

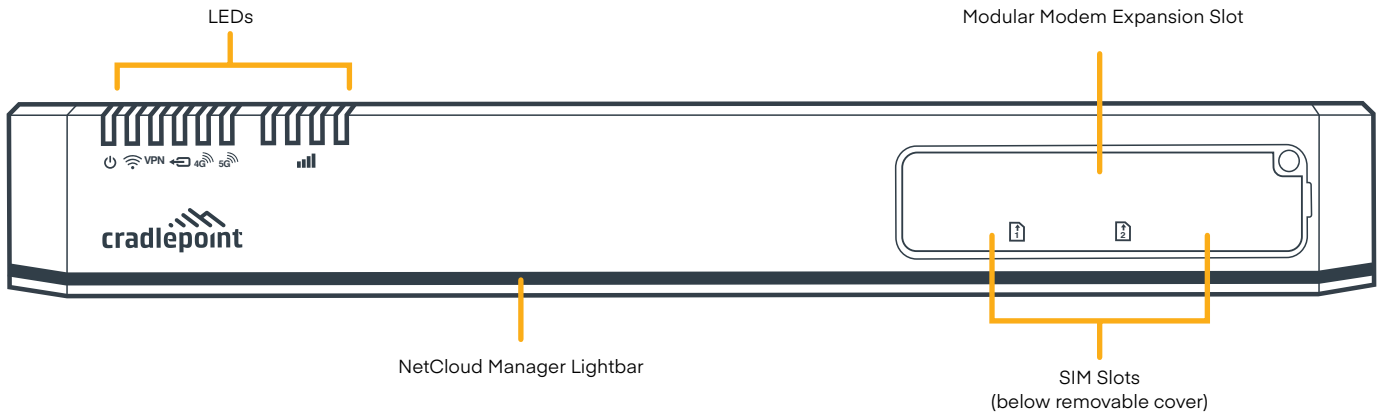

## Rear View (E3000-C18B model)

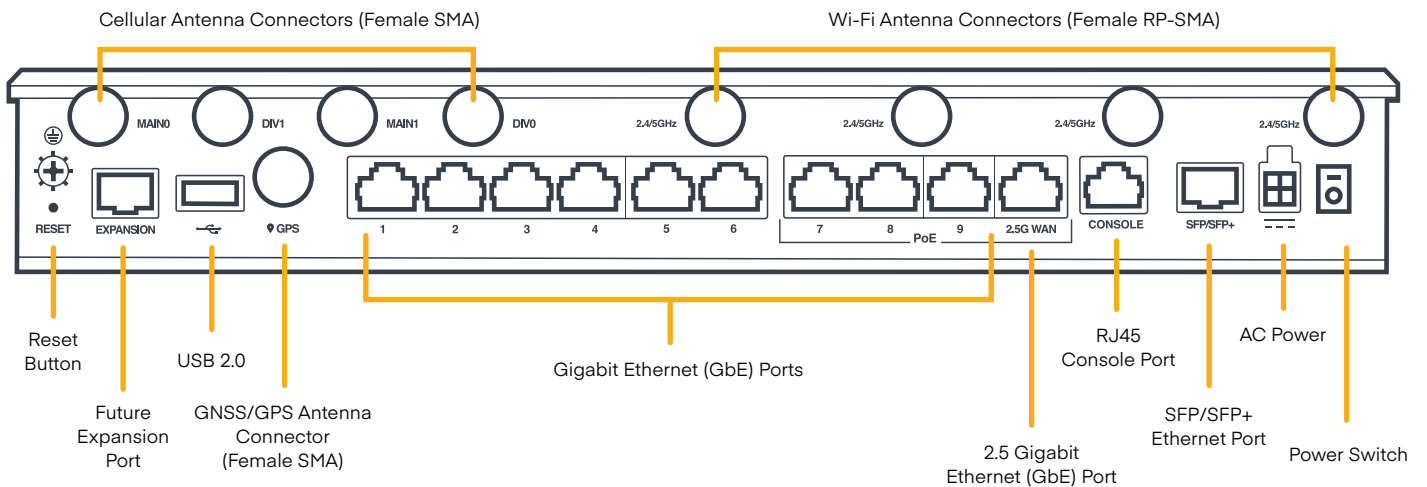

## Ordering Guide

**NetCloud Enterprise Branch Essentials** packages and plans contain all the features and capabilities required for small to mid-sized branch applications. Essentials Packages include 24x7 support (phone support: 24 hour weekdays with emergency response on weekends, web: 24x7, chat: 24x5) and a limited lifetime warranty.

For additional capabilities, a **NetCloud Enterprise Branch Advanced Plan** can be added to the NetCloud Enterprise Branch Essentials Package at any time.

See additional details of what is included in the Essential and Advanced NetCloud software: [cradlepoint.com/netcloud-service](https://cradlepoint.com/netcloud-service)

For more details on the E3000 series router, included with the NetCloud Enterprise Branch Packages, see below.

## NetCloud Package & Plans

REGION	DESCRIPTION	PART NUMBER
<b>North America:</b> U.S., Canada & Latin America	<b>CAT 18 Modem</b>	
	NetCloud Enterprise Branch Essentials and Advanced Plans with E3000-C18B	BFAx-3000C18B-GN
	NetCloud Enterprise Branch Essentials Plan with E3000-C18B	BF0x-3000C18B-GN
	NetCloud Enterprise Branch Essentials and Advanced Plans with E3000-C18B	BFAx-3000C18B-MX
	NetCloud Enterprise Branch Essentials Plan with E3000-C18B	BF0x-3000C18B-MX
	<b>5GB Modem</b>	
	NetCloud Enterprise Branch Essentials and Advanced Plans with E3000-5GB	BFAx-30005GB-GN
	NetCloud Enterprise Branch Essentials Plan with E3000-5GB	BF0x-30005GB-GN
<b>Europe:</b> European Union (EU)	<b>CAT 18 Modem</b>	
	NetCloud Enterprise Branch Essentials and Advanced Plans with E3000-C18B	BFAx-3000C18B-GE
	NetCloud Enterprise Branch Essentials Plan with E3000-C18B	BF0x-3000C18B-GE
	<b>5GB Modem</b>	
	NetCloud Enterprise Branch Essentials and Advanced Plans with E3000-5GB	BFAx-30005GB-GE
	NetCloud Enterprise Branch Essentials Plan with E3000-5GB	BF0x-30005GB-GE
<b>Europe:</b> United Kingdom (UK)	<b>CAT 18 Modem</b>	
	NetCloud Enterprise Branch Essentials and Advanced Plans with E3000-C18B	BFAx-3000C18B-GU
	NetCloud Enterprise Branch Essentials Plan with E3000-C18B	BF0x-3000C18B-GU
	<b>5GB Modem</b>	
	NetCloud Enterprise Branch Essentials and Advanced Plans with E3000-5GB	BFAx-30005GB-GU
	NetCloud Enterprise Branch Essentials Plan with E3000-5GB	BF0x-30005GB-GU

## NetCloud Package & Plans

REGION	DESCRIPTION	PART NUMBER
	<b>CAT 18 Modem</b>	
<b>Asia Pacific:</b> Australia & New Zealand (NZ)	NetCloud Enterprise Branch Essentials and Advanced Plans with E3000-C18B	BFAx-3000C18B-GP
	NetCloud Enterprise Branch Essentials Plan with E3000-C18B	BF0x-3000C18B-GP
	<b>5GB Modem</b>	
	NetCloud Enterprise Branch Essentials and Advanced Plans with E3000-5GB	BFAx-30005GB-GP
	NetCloud Enterprise Branch Essentials Plan with E3000-5GB	BF0x-30005GB-GP
<b>Asia Pacific:</b> Japan (JP)	<b>5GB Modem</b>	
	NetCloud Enterprise Branch Essentials and Advanced Plans with E3000-5GB	BFAx-30005GB-JJ
	NetCloud Enterprise Branch Essentials Plan with E3000-5GB	BF0x-30005GB-JJ
<b>All Regions:</b>	Renewal NetCloud Enterprise Branch Advanced Plan	BF0x-NCADV
	Renewal NetCloud Enterprise Branch Essentials and Advanced Plans	BFAx-NCEA-R
	Renewal NetCloud Enterprise Branch Essentials Plan	BFAx-NCESS-R

*x = 1, 3, or 5 years*



## Accessories

INCLUDED	PART NUMBER
One of the following power supplies:	
— Power Supply, 54V, 3.3A, 2x2 Large, 2 meters (most of World)	170751-000
— Power Supply, 54V, 3.3A, 2x2 Large, 2 meters (Mexico)	170751-001
C14 Line Cord (Qty. 1, varies based on the regional NetCloud package ordered)	N/A
Cellular Antenna, Charcoal, 600 MHz - 6 GHz, SMA (Qty 4)	170801-000
Wi-Fi Antenna, Charcoal, Dual-Band 2.4/5 GHz, RPSMA (Qty 4)	170836-000
Antenna Alignment Tool (E3000-C18B models only)	N/A
Wall Mount Screw Pack	N/A
Rack Mount Brackets	N/A
Rubber Feet for Desk Mounting	N/A
OPTIONAL	PART NUMBER
Power Supply C14 Line Cord Options:	
— Line Cord, U.S. (C14), 1.8 meters, North America	170671-001
— Line Cord, EU (C14), 1.8 meters, European Union	170671-002
— Line Cord, UK (C14), 1.8 meters, United Kingdom	170671-003
— Line Cord, AU (C14), 1.8 meters, Australia	170671-004
Enterprise Branch E3000 Cat 18 LTE Advanced Pro Modular Modem Kit†	BF-MC400-1200M-B
— MC400-1200M-B Cat 18 LTE Advanced Pro Modular Modem	MC400-1200M-B
— E3000 MC400-1200M-B Modem Door with Screw	N/A
— Cellular Antenna, Charcoal, 600 MHz - 6 GHz, SMA (Qty 4)	170801-000
Enterprise Branch E3000 Cat 6 LTE Advanced Modular Modem Kit†	BF-MC400LP6
— MC400LP6 Cat 6 LTE Advanced Pro Modular Modem	MC400LP6
— Cellular Antenna, Charcoal, 600 MHz - 6 GHz, SMA (Qty 2)	170801-000
Bluetooth Low Energy 5.1 (BLE) Module for E300 and E3000 Series Routers	BF-MC20-BT

† Refer to the [Cradlepoint MC400 Modular Modem](#) webpage for more information about modular modems.

## Support & Warranty

The E3000 Series router is only sold as a component of NetCloud Branch Packages.

- NetCloud Packages include support for the full subscription term.
- All Cradlepoint hardware products are covered by a limited lifetime warranty for as long as they have a subscription license to an active NetCloud Service Plan.

**Find the most up-to-date information at [cradlepoint.com/e3000](https://www.cradlepoint.com/e3000)**