



InHand ODU2002 Outdoor Unit Quick Installation Guide

Data Version: V1.3

Table of Contents

Overview.....	1
1. Packing list.....	1
2. Panel Introduction.....	2
3. Equipment Installation.....	2
3.1 Insert SIM card.....	2
3.2 Attach antennas.....	3
3.3 Install the ODU2002.....	4
3.4 Cable installation.....	6
3.4.1 Grounding.....	6
3.4.2 Connect the Ethernet Cable.....	7
3.4.3 Connect PoE Power Adapter.....	8
3.5 Inspection after Installation.....	8
3.5.1 Check the Device Installation.....	8
3.5.2 Check the Cable Connection.....	9
3.5.3 Check the Power Supply.....	9
4. Access to Internet.....	9
4.1 SIM Card Dial-up.....	9
4.1.1 Connect via APP.....	9
4.2.1 Connect via PC.....	12
4.2 Wired Networking.....	14
4.2.1 Connect via APP.....	14
4.2.1 Configure via PC.....	16
5. Remote Manage Platform.....	19
5.1 InCloud Platform.....	19
5.1.1 Register/login to the Platform.....	19
5.1.2 Adding devices to the Platform.....	20
6. Quick User Guide.....	20
6.1 Restore to Default Factory Settings.....	20
6.1.1 Reset/Restore Remotely.....	20
6.1.2 Hardware Restore.....	21
6.2 Log and Diagnostic Data.....	21
7. LED Status Reference.....	22

Overview

This manual is for the installation and operation of the ODU2002 5G outdoor unit of Inhand Networks. Before installation, please confirm the product model and accessories in the package and purchase a SIM card from the operator that supports the local network. Please refer to the actual product for specific operations.

1. Packing list

Every ODU2002 product shipped from the factory includes common accessories. After you receive our product, please check carefully. If you find any missing or damaged, please contact Inhand sales personnel in time.

Part Name	Quantity	Description
ODU2002	1	ODU2002 5G outdoor unit
Ethernet cable	1	1m Ethernet cable
Power adapter + AC	1	50V/0.3A PoE power adapter support IEEE 802.3af standard
5G antenna	2	5G antenna*2
5G MIMO antenna	4	5G MIMO antenna*4
Wi-Fi antenna	1	Wi-Fi antenna*1
GNSS antenna	1	GNSS antenna*1
QSG	1	Quick Installation Guide
Mounting bracket	1	Adjustable bracket
Mounting plate	1	Mounting plate
Stainless steel pipe clamp	2	Support pole-mounted installation
Grounding wire	1	Ground connection

2. Panel Introduction

ODU2002NA

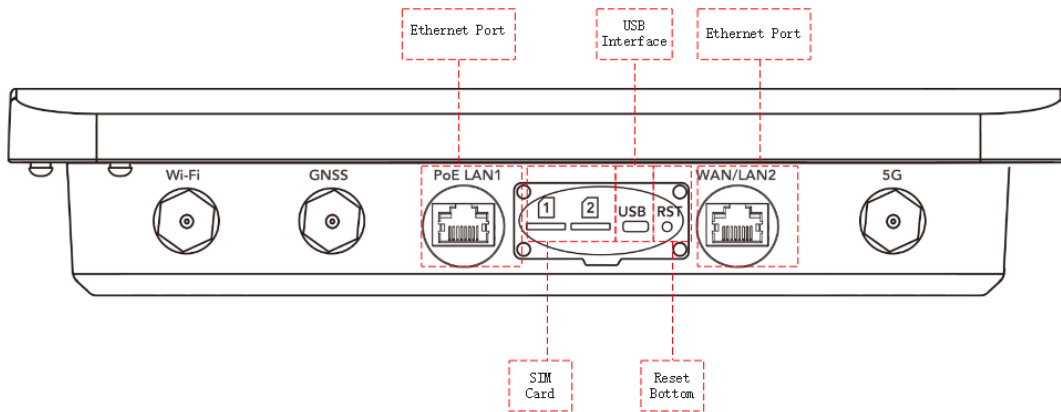

3. Equipment Installation

Precautions for installation:

- Power supply: ODU2002 is powered by 802.af standard (50V/0.3A), please pay attention to the power voltage level.
- Environmental requirements: working temperature: $-30^{\circ}\text{C} \sim 70^{\circ}\text{C}$, storage temperature: $-40^{\circ}\text{C} \sim 85^{\circ}\text{C}$.
- Support to be mounted with bracket. Avoid direct sunlight, away from heat source or strong electromagnetic interference. Confirm that the installation position is strong enough to support the weight of the equipment and its installation accessories.
- Check for cables and antennas required for installation.

3.1 Insert SIM card

- ODU2002 supports dual nano SIM cards
- Unscrew the SIM card cover of the ODU2002, then insert the SIM card(s) according to the following diagram.

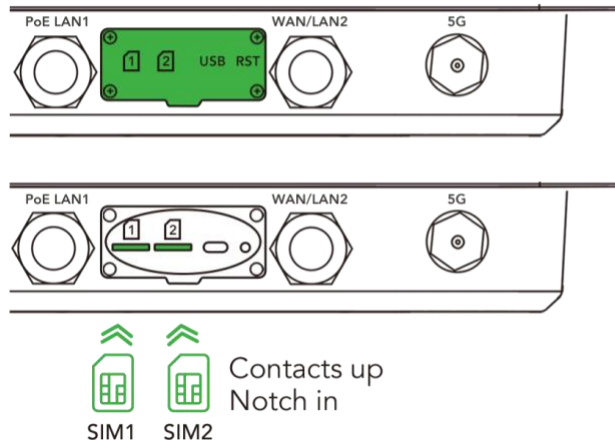

- Put the SIM card cover back in place, make sure the waterproof gasket is properly assembled to prevent leakage.

3.2 Attach antennas

- Attach eight antennas to the TNC connectors marked 5G/5G MIMO/Wi-Fi and GNSS.

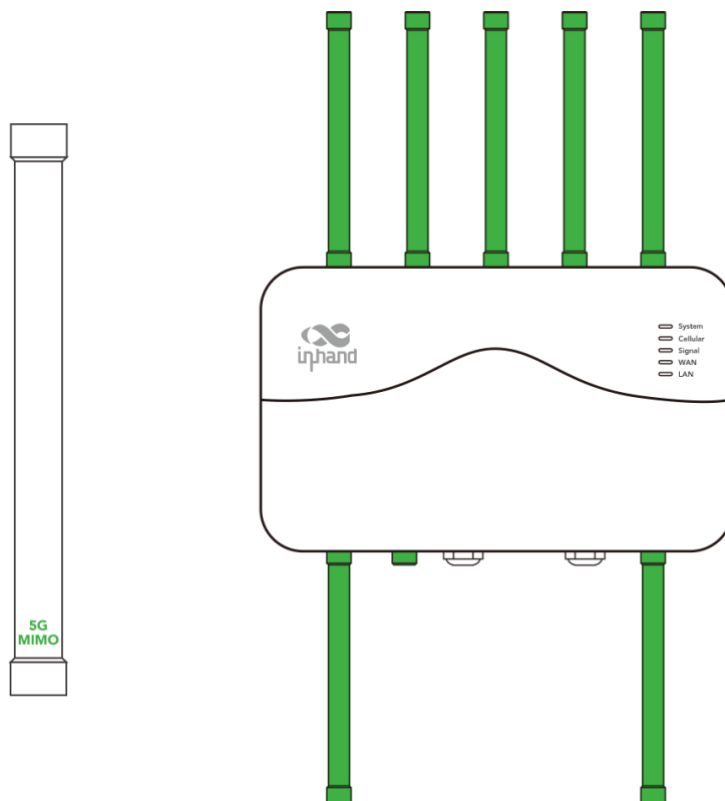

3.3 Install the ODU2002

3.3.1 Install the Mounting plate

- Attach the mounting plate to the ODU2002 using screws. Please make sure the top side facing upwards.

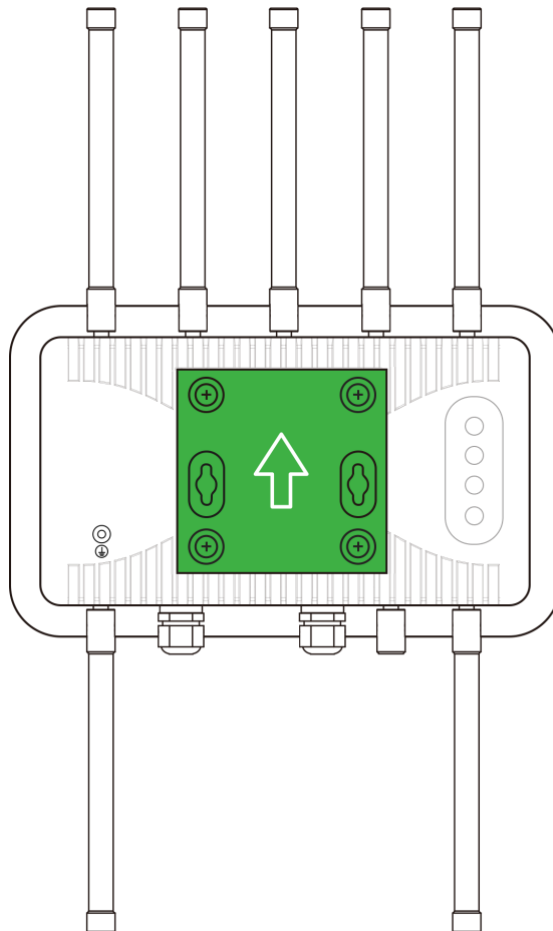

3.3.2 Wall-mounted Installation

- Install the adjustable base on the wall in the desired angle and position.

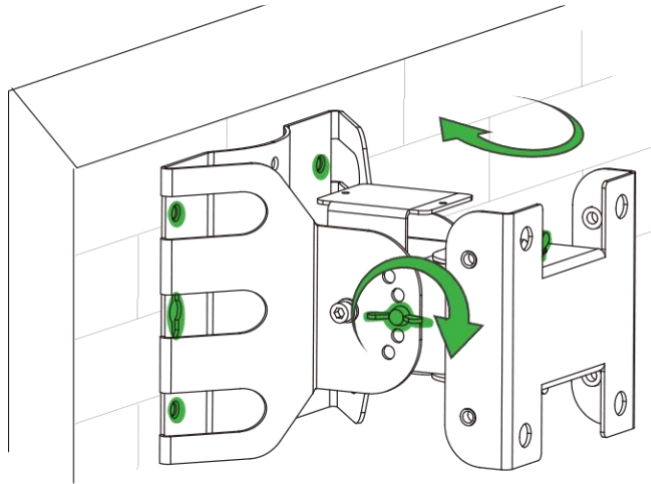

- Attach the mounted ODU2002 to the base. Tighten the mounting bolts to lock the ODU2002 in place.

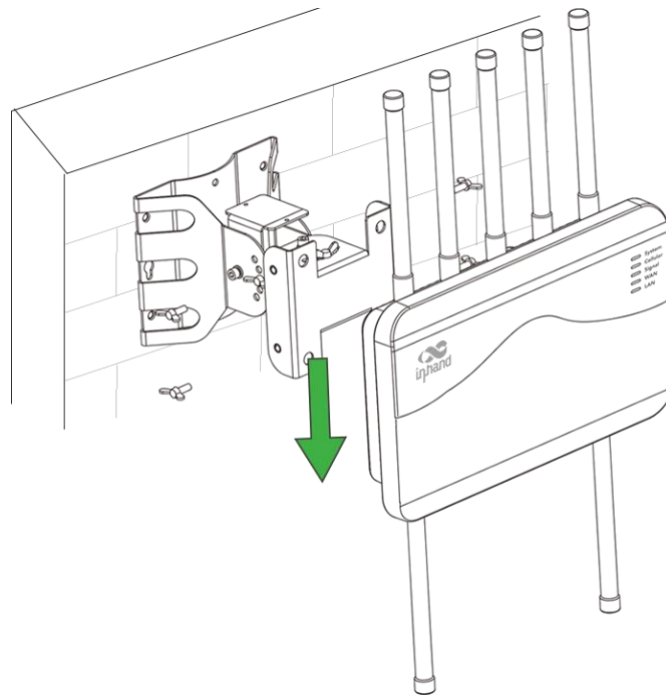

3.3.3 Pole-mounted Installation

- Install the adjustable base on the pole in the desired angle and position.

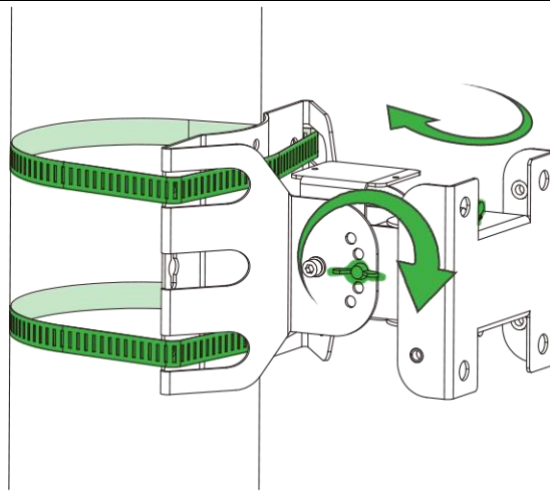

- Attach the mounted ODU2002 to the base. Tighten the mounting bolts to lock the ODU2002 in place.

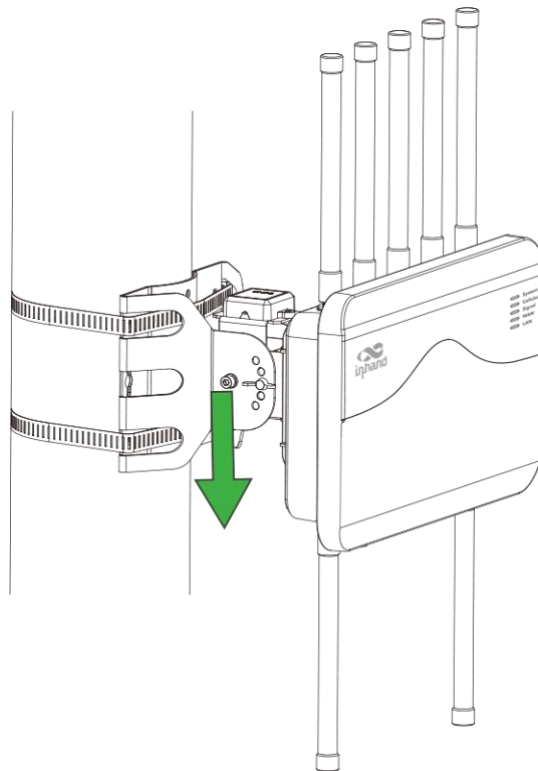

3.4 Cable installation

3.4.1 Grounding

- Connect the grounding hole of the device to the ground through the grounding wire with OT terminal, cut the grounding wire into certain length according to field

situation to avoid waste.

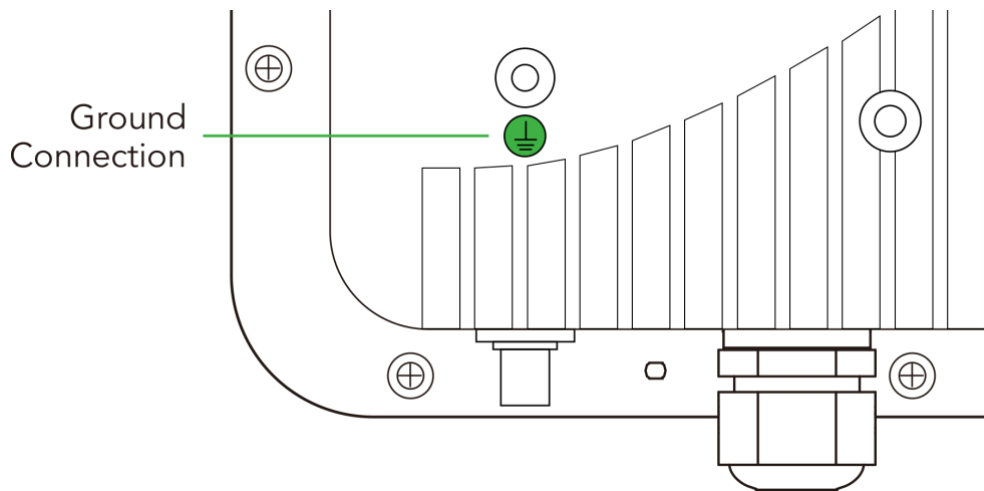

3.4.2 Connect the Ethernet Cable

⚠ Notice

- (1) Please make sure that the ethernet cable is inserted into the device in a standardized way. If not, the crystal head may be damaged when installing the waterproof PG head.
- (2) When removing the ethernet cable, the waterproof PG head must be removed first, and then the crystal head connected to the device must be removed.
- (3) Please confirm the diameter of Ethernet cable is between 4.8 mm to 6.5 mm.
- (4) Please ensure the cable glands are properly assembled to prevent leaks.

- Cut the Ethernet cable to the appropriate length according to the distance from the ODU to the power supply and pass it through the bracket.
- Use the ethernet cable after the crystal head is processed and pass through the waterproof PG head in the order shown in the figure below.
- Schematic diagram of patch cable passing through waterproof head
- Insert the Ethernet cable into the network port of the device, and tighten the waterproof head in the order of B, C, D, E to complete the installation.

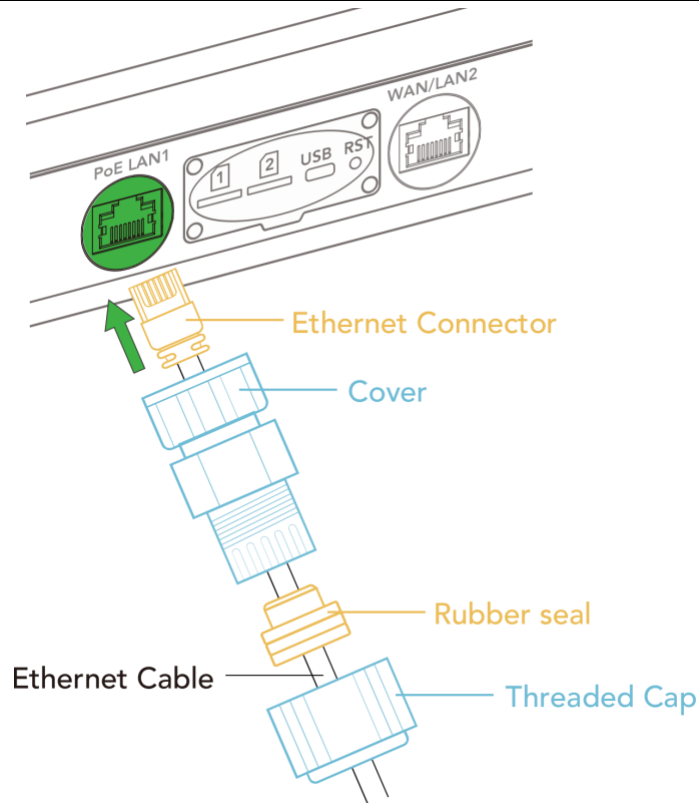

3.4.3 Connect PoE Power Adapter

- Connect one end of the Ethernet cable to the PoE 2.5G LAN1 port and plug the other end into the 802.af(50V/0.3A) PoE Adapter or an router/switch with 802.3af port.

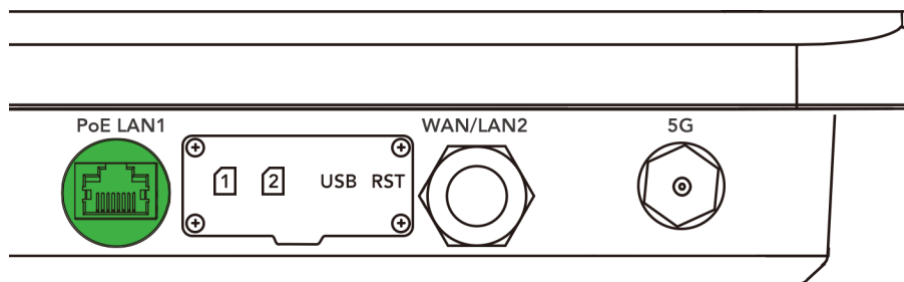

3.5 Inspection after Installation

3.5.1 Check the Device Installation

- Confirm the device is fully secured to prevent falling.

3.5.2 Check the Cable Connection

- Make sure the cables are bundled correctly.
- Avoid dragging and damaging the device, we recommend you to fix the Ethernet cable on the bracket.

3.5.3 Check the Power Supply

- Confirm that the power cord is in good contact and meets safety requirements.
- Turn on the power to supply power to the device and confirm the device can work normally.

4. Access to Internet

ODU2002 supports two ways of accessing to Internet: cellular and wired. Wi-Fi is only used for configuration.

4.1 SIM Card Dial-up

4.1.1 Connect via APP

- Insert the SIM card when device is power off, and connect the 5G antenna to the device, and log in the InCloud APP.
- Click the "Device" directory below to enter the [Device] page, click the menu

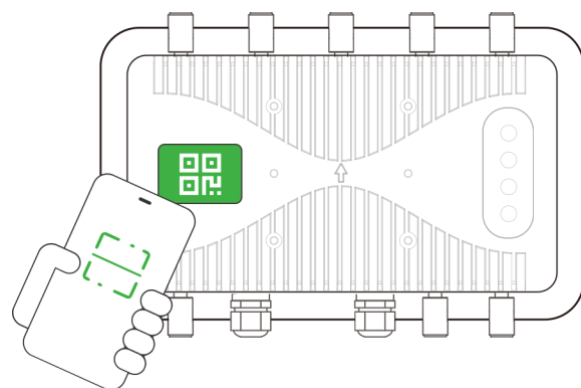
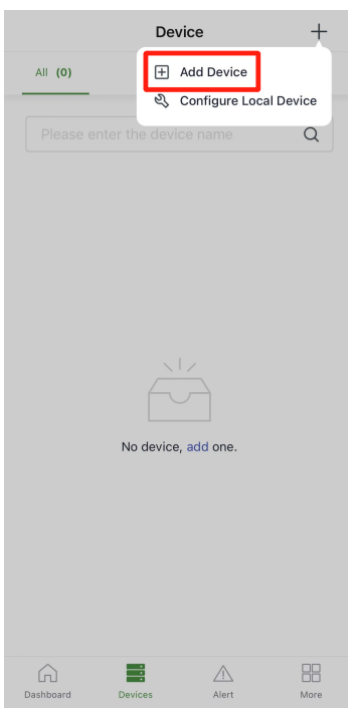

button in the upper right corner, and select [Add Device]. Scan the QR code on the ODU2002 to add device.

- After scanning the code successfully, configure the name, serial number, and description information of the device.

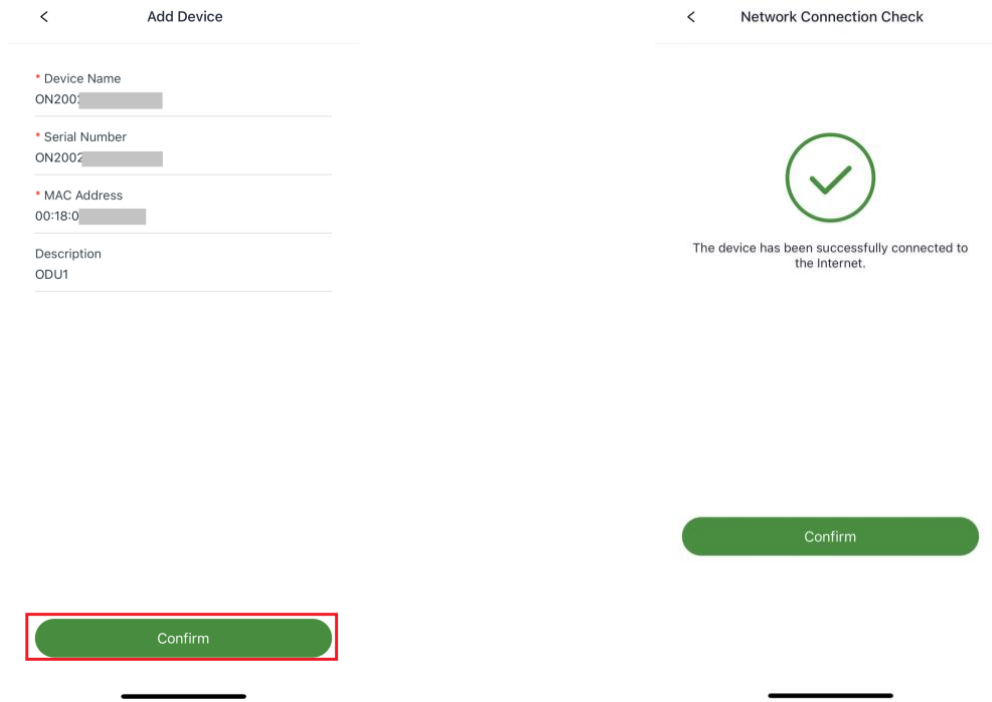

- After adding the device, if the device fails to connect to the network, you can click "Configure local device" to configure the device to connect to the cloud. The ODU2002 enables the http access and Wi-Fi AP function by default.

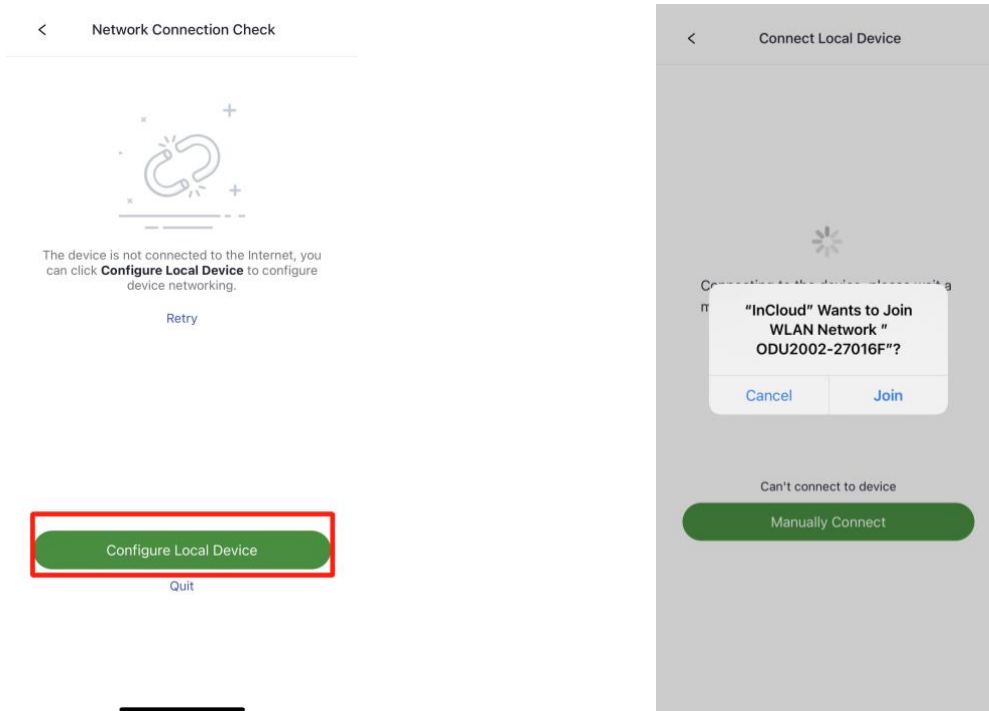

- Scan the QR code on ODU2002, and then the APP will automatically connect to the device via Wi-Fi.
- After the connection succeeds, APP will will automatically log in to the device and enter the networking configuration interface, confirm the information and submit.

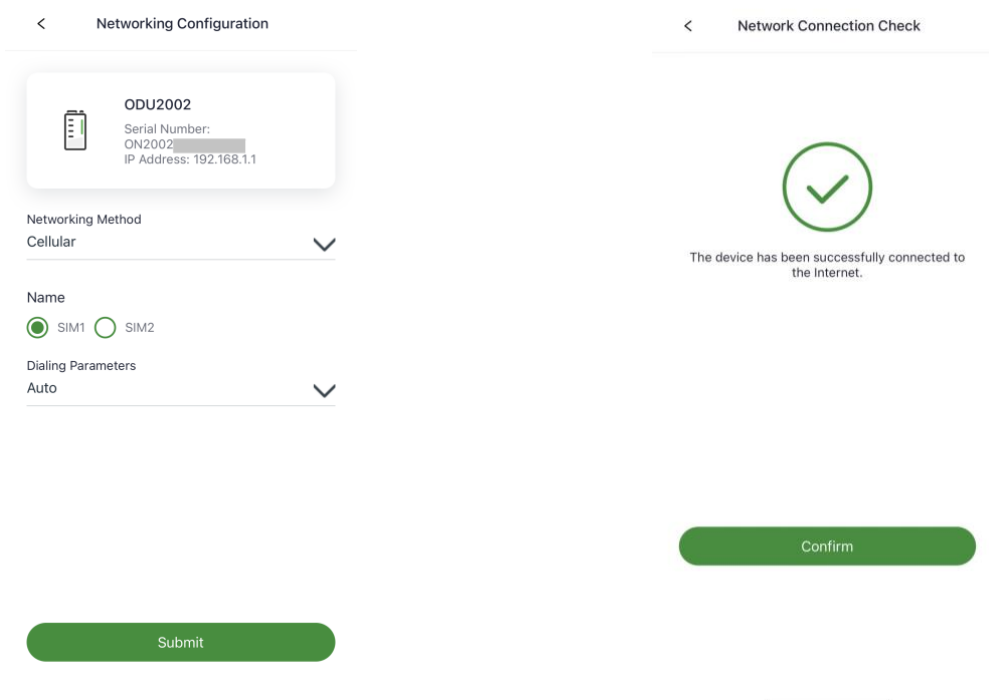

4.2.1 Connect via PC

- Step 1: Power off the device, insert the SIM card into the card slot, connect the 5G antenna to the device, connect ODU2002 and PC with Ethernet cable.
- Step 2: Open a browser and enter the device's default address 192.168.1.1 in the browser address bar. After entering the username and password (default: adm/123456), enter the device's WEB management interface. If the page prompts that the webpage is not secure, open the hidden or advanced options and select "Proceed to website".

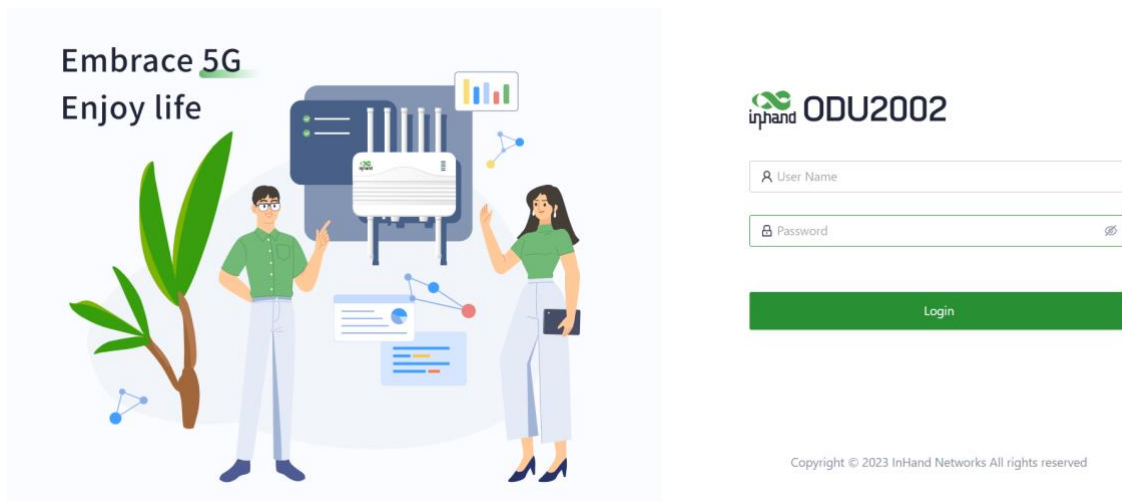

- Step 3: Click "Internet" on the left navigation bar, click the edit button behind the "Cellular" button to set up the dial-up parameters, the device enables the dial-up function by default, wait for a few minutes to go online, and re-enable the dial-up if it is not dialed.

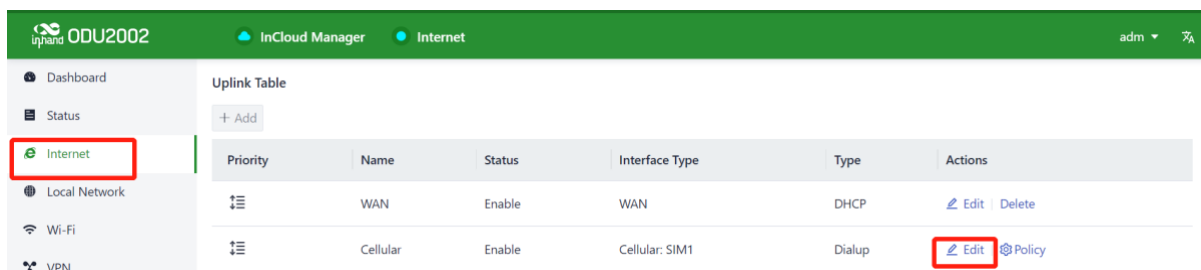

Edit Cellular [X]

Status:

NAT:

Work Mode: Only SIM1 [v]

Dialing Parameters: Auto [v]

Service Type: Auto [Auto]

PIN Code: []

IMS: Auto [v]

* MTU: Auto [v]

Mask: 255.255.255.255

[Cancel] [Save]

- Step 4: Check the dial-up status in the "Interface Status" of the "Dashboard". The device connects to the Internet successfully if the "Cellular" icon turns green. Click the "Cellular" icon to view information such as signal strength, IP address, and traffic consumption.

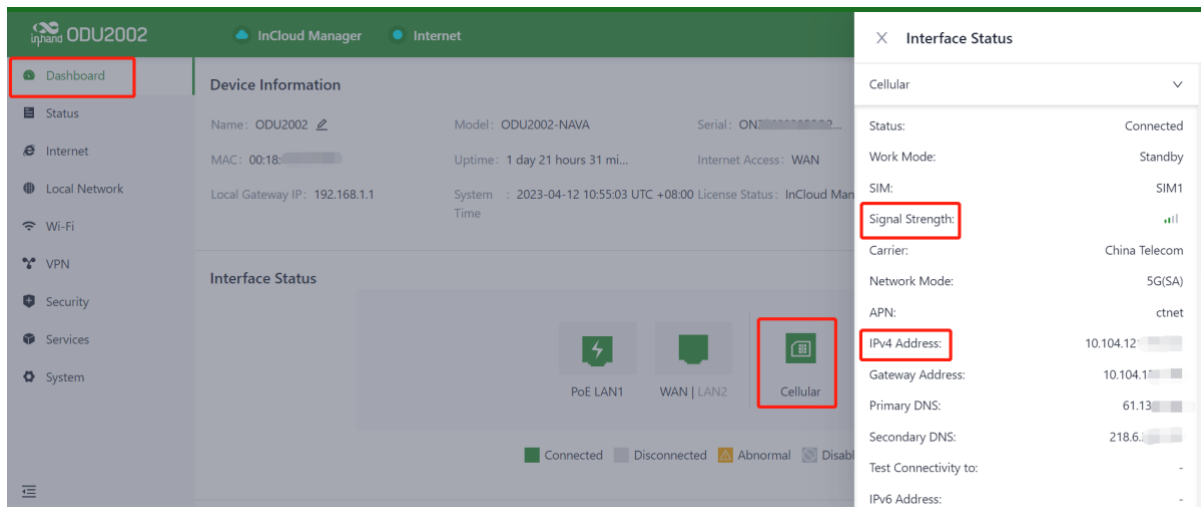

The screenshot shows the InHand Networks management interface for device ODU2002. The 'Dashboard' menu item is highlighted with a red box. The 'Interface Status' section shows three icons: PoE LAN1, WAN | LAN2, and Cellular. The Cellular icon is highlighted with a red box and is green, indicating it is connected. A pop-up window titled 'Interface Status' is open for the Cellular interface, showing the following details:

Cellular	[v]
Status:	Connected
Work Mode:	Standby
SIM:	SIM1
Signal Strength:	[Bar chart]
Carrier:	China Telecom
Network Mode:	5G(SA)
APN:	ctnet
IPv4 Address:	10.104.12 [Bar chart]
Gateway Address:	10.104.1 [Bar chart]
Primary DNS:	61.13 [Bar chart]
Secondary DNS:	218.6 [Bar chart]
Test Connectivity to:	-
IPv6 Address:	-

4.2 Wired Networking

4.2.1 Connect via APP

- Step1: Click the "Device" directory below to enter the [Device] page, click the menu button in the upper right corner, and select [Add Device]. Scan the QR code on the ODU2002 to add device.

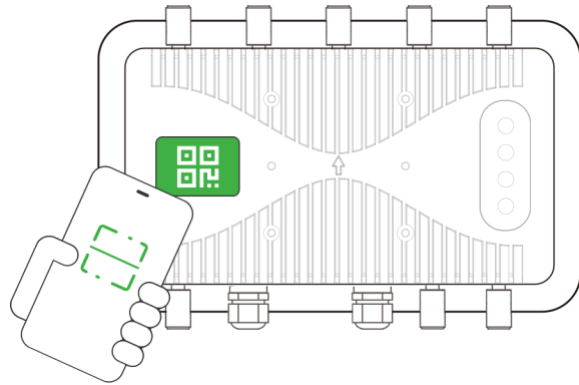
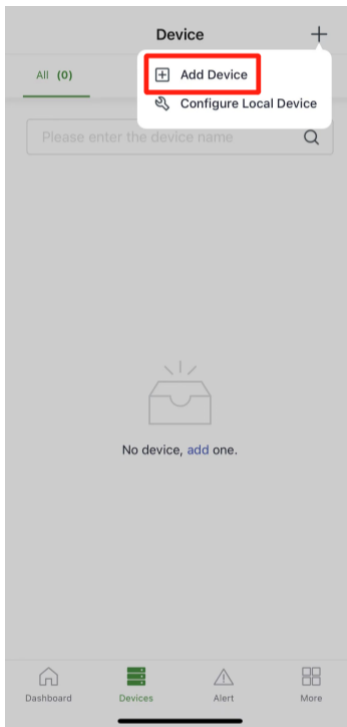

- After scanning the code successfully, configure the name, serial number, and description information of the device.

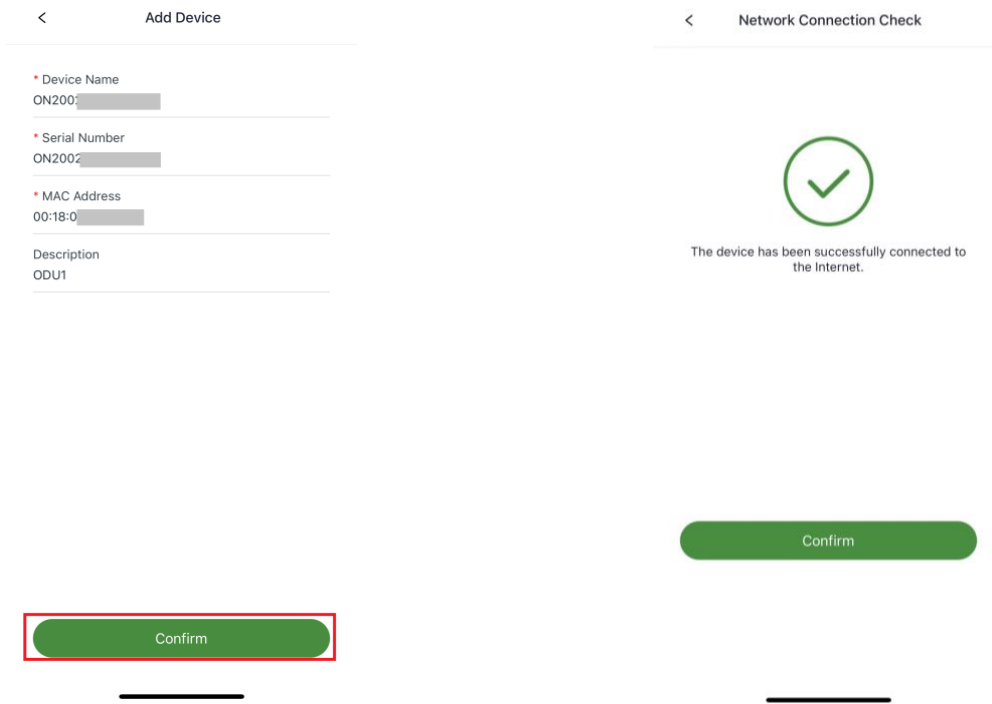

- After adding the device, if the device fails to connect to the network, you can click "Configure local device" to configure the device to connect to the cloud. The ODU2002 enables the http access and Wi-Fi AP function by default.

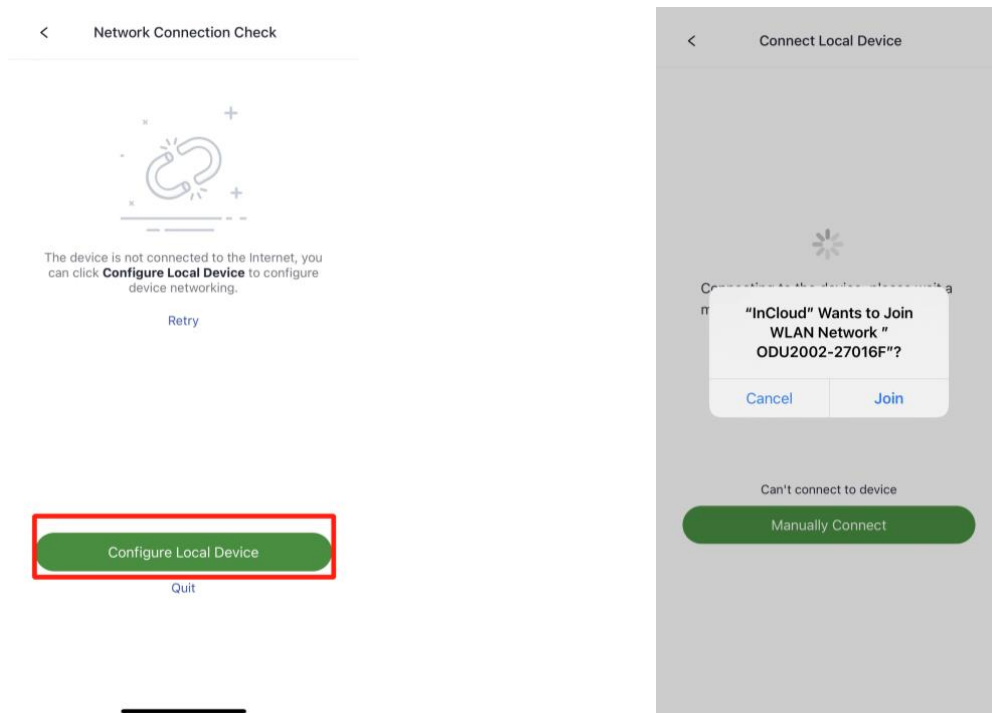

- Scan the QR code on the nameplate of the unit, then the APP will automatically connect to the ODU via Wi-Fi.
- After the connection succeeds, APP will automatically log in to the device and enter the networking configuration interface, confirm the information then submit.

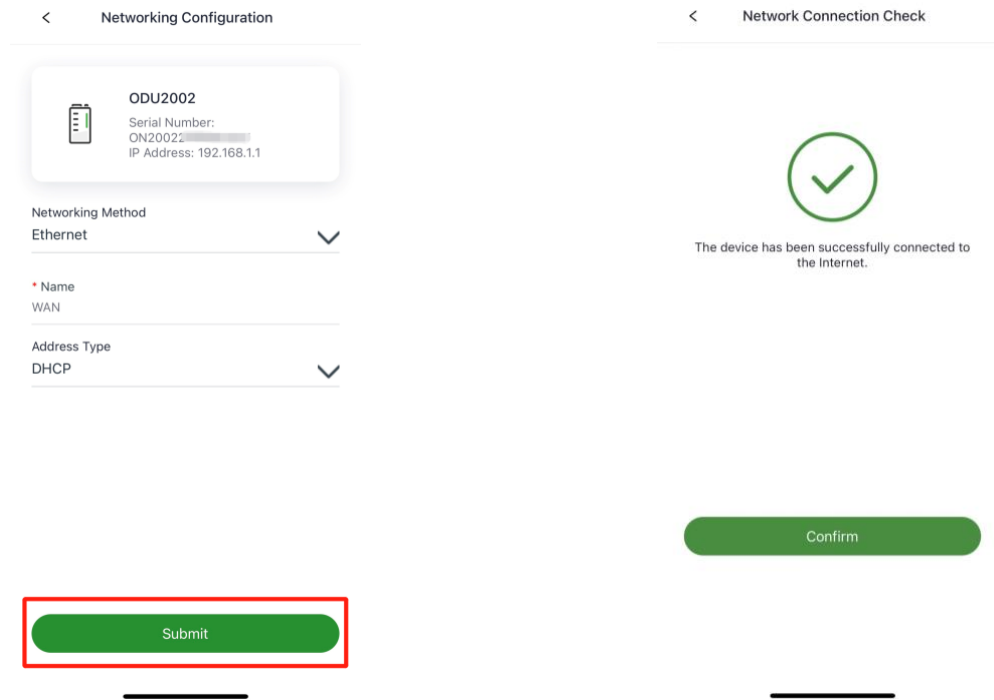

4.2.1 Configure via PC

- Step 1: Connect the LAN1 port to the PC.
- Step 2: Set the IP of the PC and the gateway device to be in the same network segment. DHCP automatically obtains the address (recommended). Use a fixed IP address. The DHCP server function is enabled by default on the LAN port of the device, and the PC and the device must be in the same segment. On PC side, the IP address needs to be configured as any address in 192.168.1.2~192.168.1.254, the gateway is set to 192.168.1.1, the subnet mask is 255.255.255.0, and the DNS configuration is 8.8.8.8/operator DNS server address.

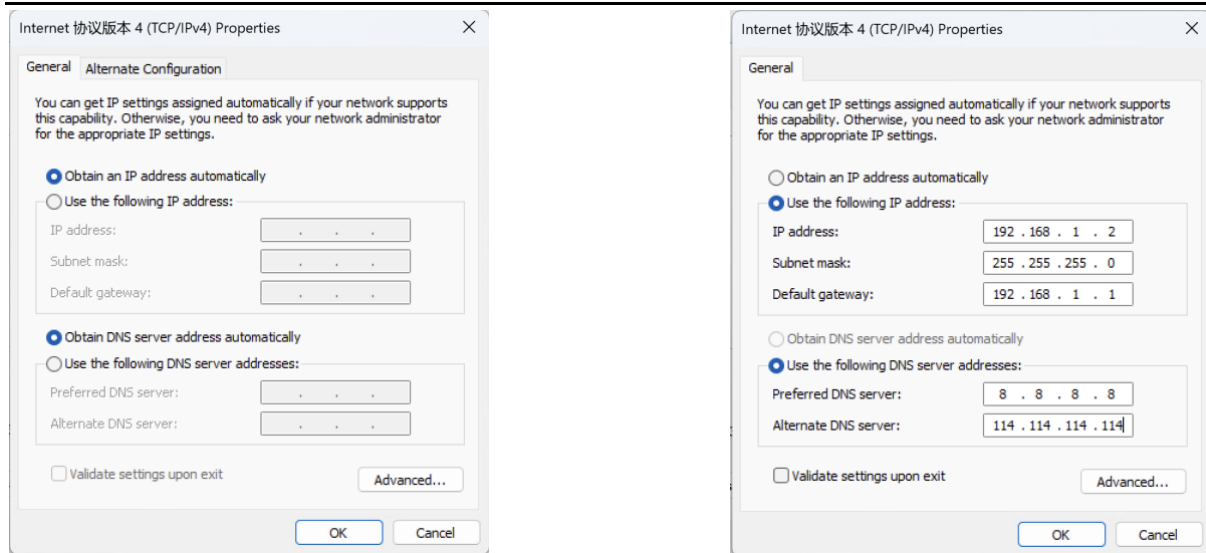

- Step 3: Enter the device default address 192.168.1.1 in the browser address bar, enter the user name and password (adm/123456 by default), and enter the device WEB management interface. If the page prompts that the webpage is not safe, turn on Hidden or Advanced, and choose to continue.



Copyright © 2023 InHand Networks All rights reserved

- Step 4: Click "Internet" on the left navigation bar to view the device interface status. ODU2002 enables WAN1 with DHCP mode by default. ODU2002 supports three methods to allocate WAN address, dynamic DHCP (recommended), static IP and PPPoE. Click the Edit button next to WAN to modify the WAN port.
- DHCP: The DHCP service is enabled by default on the WAN interface of the device, and the ODU can be connected to the network by connecting the WAN interface to the Internet with a ethernet cable.
- Static IP: User can manually configure the address assigned by the operator or

the upstream device. After the configuration is completed, the router will access the network through the specified static IP.

- PPPoE: Users can configure broadband dial-up. After the configuration is completed, the router will access the network through broadband dial-up.

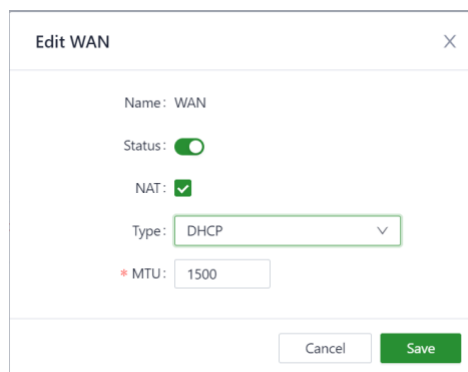
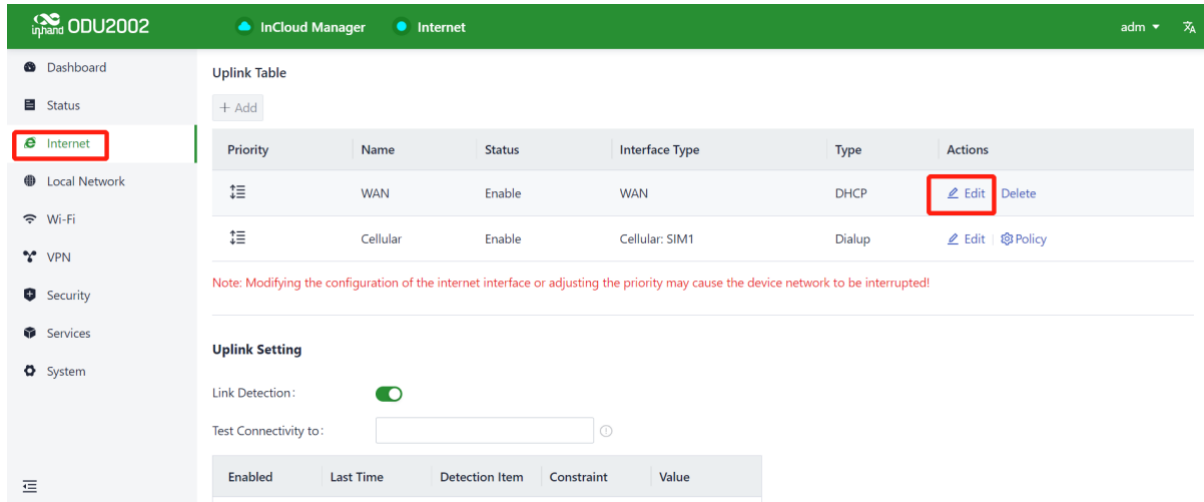

- Step 5: Verify network connectivity Via Ping tool in System/ Tools page.

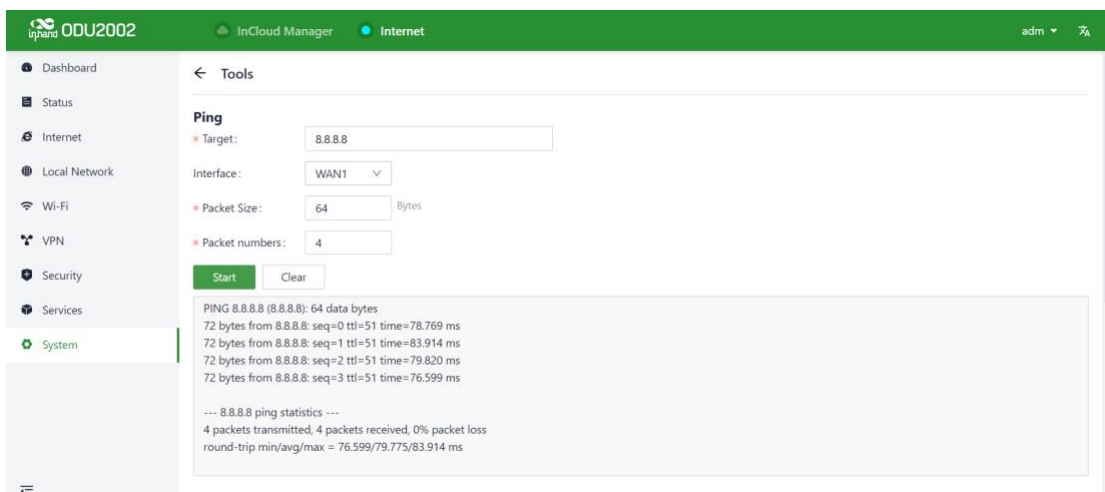

5. Remote Manage Platform

5.1 InCloud Platform

5.1.1 Register/login to the Platform

- Use a browser to visit InCloud, address: <https://star.inhandcloud.com/>, and enter InCloud registration and login page. (Chrome is recommended)

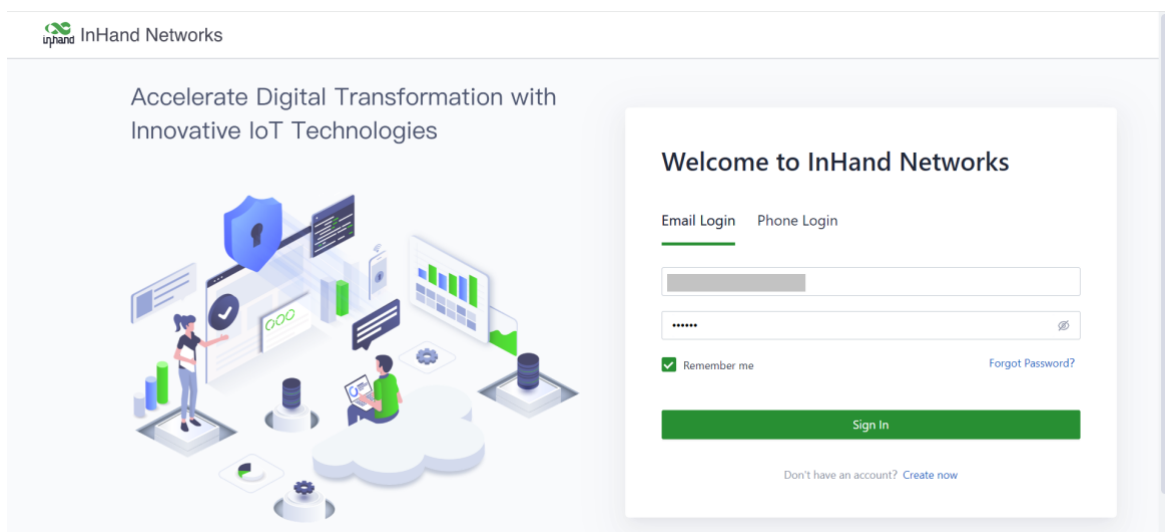

- After registration, login to the cloud platform with the registered email. Enter the "Security Settings" page to change your password and bind your mobile phone number; after binding your mobile phone number, you can use your mobile phone number to log in to the cloud platform next time.

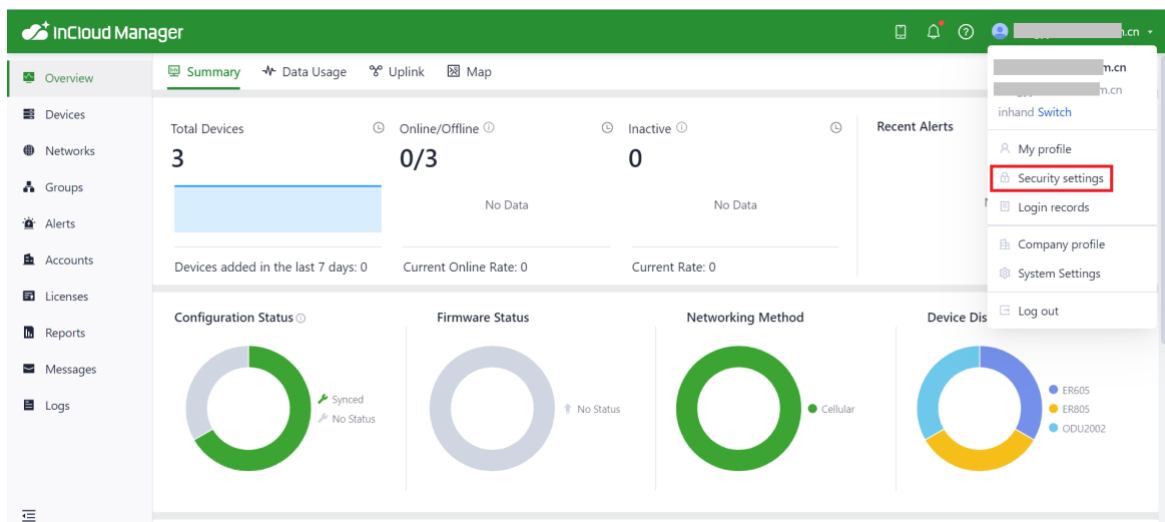

5.1.2 Adding devices to the Platform

- Log in to InCloud Manager platform, click "Device >> Add" in the navigation menu to add your device by filling device's serial number.

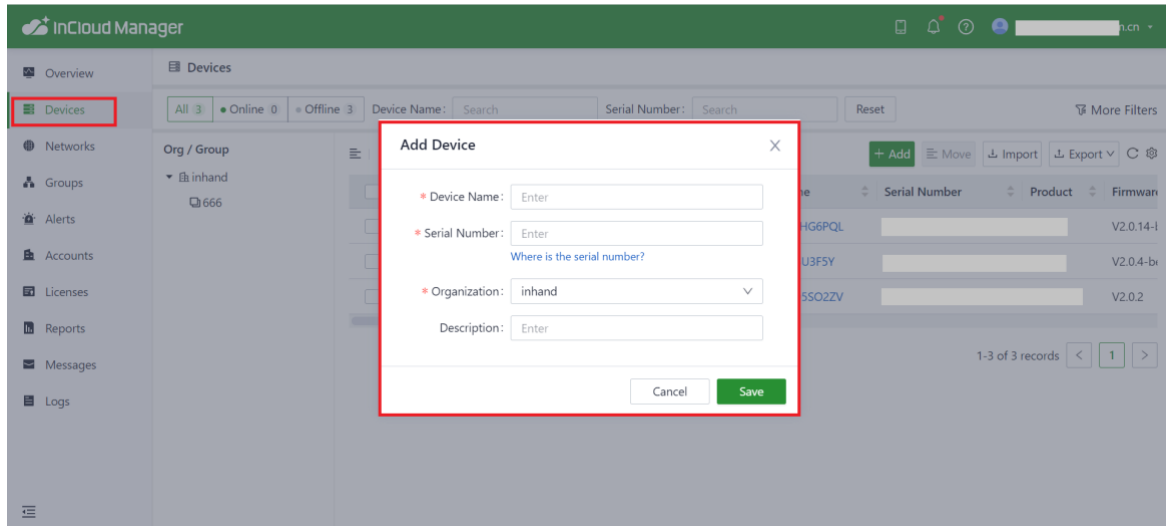

6. Quick User Guide

6.1 Restore to Default Factory Settings

6.1.1 Reset/Restore Remotely

- Log in to the InCloud Manager platform, click "Device >> Command" in the navigation bar, click the "Restore to Factory" button and after confirm, device will reboot and restore to default settings.

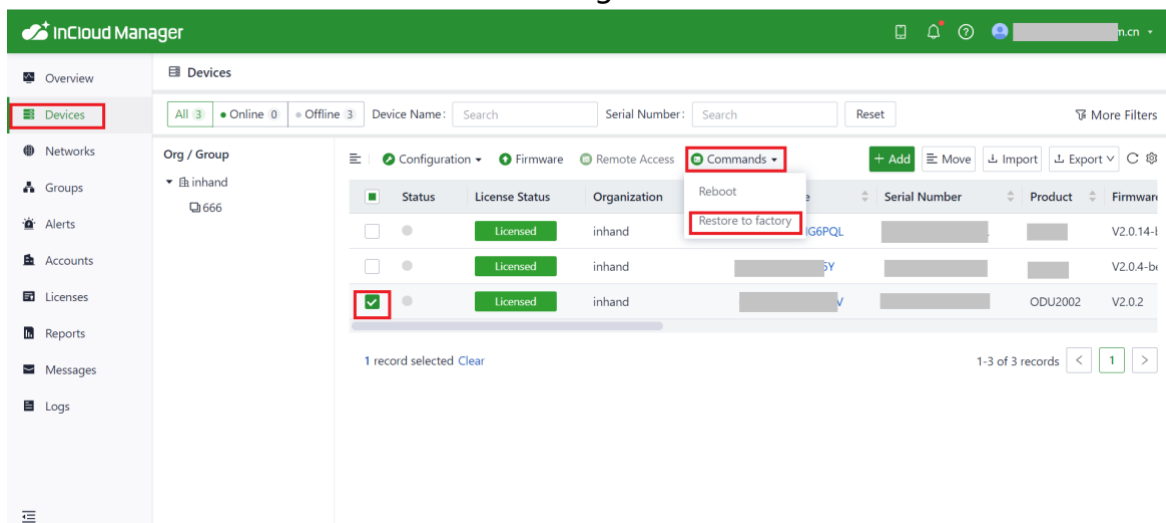

6.1.2 Hardware Restore

To restore to default settings by the reset button, please perform the following steps:

- When the unit power ON, press and hold the reset button for 5-10 seconds.
- When System LED is steady on blue, release RESET button, system LED will blink in blue, and press the RESET button again.
- When System LED is steady on blue, release the RESET button. The unit has been restored to default settings and will start up normally later.

6.2 Log and Diagnostic Data

- Login to InCloud Manager, click the "Device >> Device Details >> Tools" menu in the navigation bar, and click the corresponding button to complete the download of logs and diagnostic data.

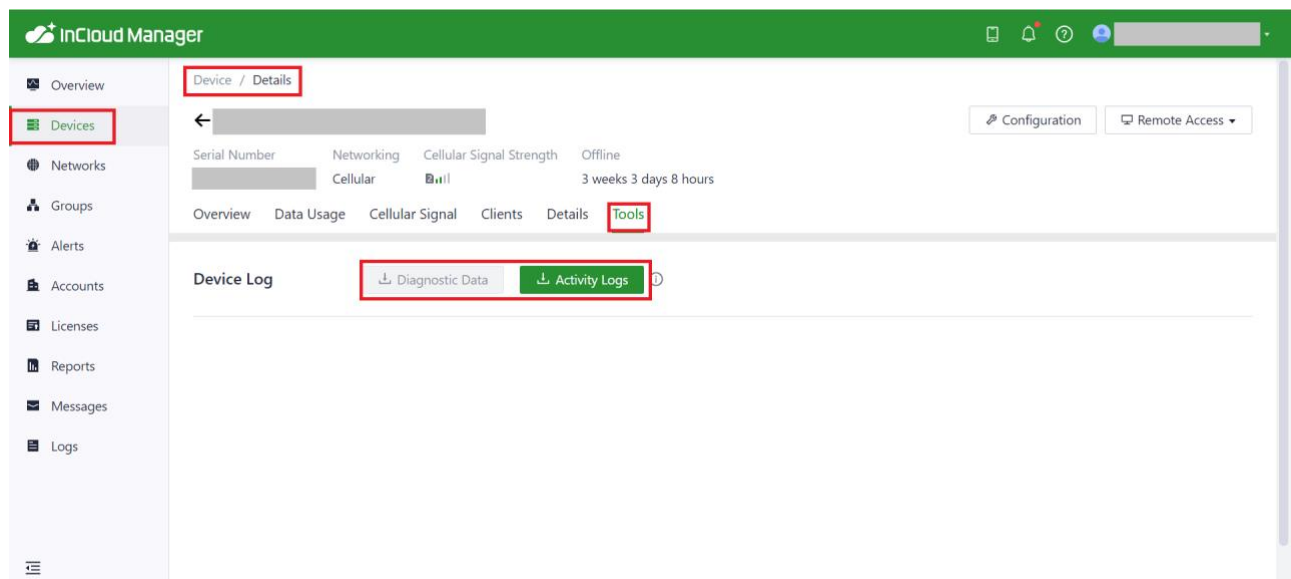

7. LED Status Reference

ODU2002NAVA

ODU2002 Indicator light	LED status and definition
System	Off --- Power off Steady in red --- System starting Blink in red --- System error Steady in green --- System working Blink in blue --- System upgrading
Cellular	Off --- Cellular disable Steady in blue --- 4G dialed up Steady in green --- 5G dialed up Blink in red --- Connection error
Signal	Off --- Connection error Steady in red --- Signal value ≤ 9 . Steady in blue --- $10 \leq \text{Signal level} \leq 19$ Steady in green --- Signal level ≥ 20 ,
LAN	Off --- Connection error Steady in green --- LAN port connected Blink in green --- LAN port data transmitting
WAN	Off --- Connection error Steady in green --- WAN port connected Blink in green --- WAN port data transmitting